

55

(12) INTERNATIONAL APPLICATION PUBLISHED UNDER THE PATENT COOPERATION TREATY (PCT)

(19) World Intellectual Property Organization International Bureau



(43) International Publication Date 17 June 2004 (17.06.2004)

PCT

(10) International Publication Number WO 2004/050172 A1

(51) International Patent Classification⁷: A61N 1/00, A61B 5/00, A61H 1/00

(21) International Application Number: PCT/US2003/038579

(22) International Filing Date: 3 December 2003 (03.12.2003)

(25) Filing Language: English

(26) Publication Language: English

(30) Priority Data: 60/430,700 4 December 2002 (04.12.2002) US; Not furnished 2 December 2003 (02.12.2003) US

(71) Applicant (for all designated States except US): KINETIC MUSCLES, INC. [US/US]; 2103 E. Cedar Street, Suite 3, Mesa, AZ 85281 (US).

(72) Inventors; and

(75) Inventors/Applicants (for US only): KOENEMAN, Edward, J. [US/US]; 2103 E. Cedar Street, Suite 3, Mesa, AR 85281 (US). KOENEMAN, James, B. [US/US]; 2103 E. Cedar Street, Suite 3, Mesa, AZ 95281 (US). HERRING, Donald, E. [US/US]; 2103 E. Cedar Street, Suite 3, Mesa, AZ 95281 (US). SCHULTZ, Robert, S. [US/US]; 2103 E. Cedar Drive, Suite 3, Mesa, AZ 85281 (US).

(74) Agents: DARROW, Christopher et al.; Greenberg Traurig LLP, 2450 Colorado Avenue, Suite 400E, San Monica, CA 90404 (US).

(81) Designated States (national): AE, AG, AL, AM, AT, AU, AZ, BA, BB, BG, BR, BY, BZ, CA, CH, CN, CO, CR, CU, CZ, DE, DK, DM, DZ, EC, EE, EG, ES, FI, GB, GD, GE, GH, GM, HR, HU, ID, IL, IN, IS, JP, KE, KG, KP, KR, KZ, LC, LK, LR, LS, LT, LU, LV, MA, MD, MG, MK, MN, MW, MX, MZ, NI, NO, NZ, OM, PG, PH, PL, PT, RO, RU, SC, SD, SE, SG, SK, SL, SY, TJ, TM, TN, TR, TT, TZ, UA, UG, US, UZ, VC, VN, YU, ZA, ZM, ZW.

(84) Designated States (regional): ARIPO patent (BW, GH, GM, KE, LS, MW, MZ, SD, SL, SZ, TZ, UG, ZM, ZW), Eurasian patent (AM, AZ, BY, KG, KZ, MD, RU, TJ, TM), European patent (AT, BE, BG, CH, CY, CZ, DE, DK, EE, ES, FI, FR, GB, GR, HU, IE, IT, LU, MC, NL, PT, RO, SE, SI, SK, TR), OAPI patent (BF, BJ, CF, CG, CI, CM, GA, GN, GQ, GW, ML, MR, NE, SN, TD, TG).

Declarations under Rule 4.17:

— as to applicant's entitlement to apply for and be granted a patent (Rule 4.17(ii)) for the following designations AE, AG, AL, AM, AT, AU, AZ, BA, BB, BG, BR, BY, BZ, CA, CH, CN, CO, CR, CU, CZ, DE, DK, DM, DZ, EC, EE, EG, ES, FI, GB, GD, GE, GH, GM, HR, HU, ID, IL, IN, IS, JP, KE, KG, KP, KR, KZ, LC, LK, LR, LS, LT, LU, LV, MA, MD, MG, MK, MN, MW, MX, MZ, NI, NO, NZ, OM, PG, PH, PL, PT, RO, RU, SC, SD, SE, SG, SK, SL, SY, TJ, TM, TN, TR, TT, TZ, UA, UG, UZ, VC, VN, YU, ZA, ZM, ZW, ARIPO patent (BW, GH, GM, KE, LS, MW, MZ, SD, SL, SZ, TZ, UG, ZM, ZW), Eurasian patent (AM, AZ, BY, KG, KZ, MD, RU, TJ, TM), European patent (AT, BE, BG, CH, CY, CZ, DE, DK, EE, ES, FI, FR, GB, GR, HU, IE, IT, LU, MC, NL, PT, RO, SE, SI, SK, TR), OAPI patent (BF, BJ, CF, CG, CI, CM, GA, GN, GQ, GW, ML, MR, NE, SN, TD, TG)

— as to applicant's entitlement to apply for and be granted a patent (Rule 4.17(ii)) for the following designations AE, AG, AL, AM, AT, AU, AZ, BA, BB, BG, BR, BY, BZ, CA, CH, CN, CO, CR, CU, CZ, DE, DK, DM, DZ, EC, EE, EG, ES, FI, GB, GD, GE, GH, GM, HR, HU, ID, IL, IN, IS, JP, KE, KG, KP, KR, KZ, LC, LK, LR, LS, LT, LU, LV, MA, MD, MG, MK, MN, MW, MX, MZ, NI, NO, NZ, OM, PG, PH, PL, PT, RO, RU, SC, SD, SE, SG, SK, SL, SY, TJ, TM, TN, TR, TT, TZ, UA, UG, UZ, VC, VN, YU, ZA, ZM, ZW, ARIPO patent (BW, GH, GM, KE, LS, MW, MZ, SD, SL, SZ, TZ, UG, ZM, ZW), Eurasian patent (AM, AZ, BY, KG, KZ, MD, RU, TJ, TM), European patent (AT, BE, BG, CH, CY, CZ, DE, DK, EE, ES, FI, FR, GB, GR, HU, IE, IT, LU, MC, NL, PT, RO, SE, SI, SK, TR), OAPI patent (BF, BJ, CF, CG, CI, CM, GA, GN, GQ, GW, ML, MR, NE, SN, TD, TG)

— as to applicant's entitlement to apply for and be granted a patent (Rule 4.17(ii)) for the following designations AE, AG, AL, AM, AT, AU, AZ, BA, BB, BG, BR, BY, BZ, CA, CH, CN, CO, CR, CU, CZ, DE, DK, DM, DZ, EC, EE, EG, ES, FI, GB, GD, GE, GH, GM, HR, HU, ID, IL, IN, IS, JP, KE, KG, KP, KR, KZ, LC, LK, LR, LS, LT, LU, LV, MA, MD, MG, MK, MN, MW, MX, MZ, NI, NO, NZ, OM, PG, PH, PL, PT, RO, RU, SC, SD, SE, SG, SK, SL, SY, TJ, TM, TN, TR, TT, TZ, UA, UG, UZ, VC, VN, YU, ZA, ZM, ZW, ARIPO patent (BW, GH, GM, KE, LS, MW, MZ, SD, SL, SZ, TZ, UG, ZM, ZW), Eurasian patent (AM, AZ, BY, KG, KZ, MD, RU, TJ, TM), European patent (AT, BE, BG, CH, CY, CZ, DE, DK, EE, ES, FI, FR, GB, GR, HU, IE, IT, LU, MC, NL, PT, RO, SE, SI, SK, TR), OAPI patent (BF, BJ, CF, CG, CI, CM, GA, GN, GQ, GW, ML, MR, NE, SN, TD, TG)

[Continued on next page]

(54) Title: A SYSTEM AND METHOD FOR NEUROMUSCULAR REEDUCATION

(57) Abstract: A system and method that promotes the restoration of physical functions of the neuromuscular system by incorporating into one device the treatment modalities of biofeedback based repetitive practice, includes an actuator, a joint position measurement system, a force sensing measurement system, an EMG measurement system, a neuromuscular low-level stimulation system, a controller, and a display device.

WO 2004/050172 A1



- as to applicant's entitlement to apply for and be granted a patent (Rule 4.17(ii)) for the following designations AE, AG, AL, AM, AT, AU, AZ, BA, BB, BG, BR, BY, BZ, CA, CH, CN, CO, CR, CU, CZ, DE, DK, DM, DZ, EC, EE, EG, ES, FI, GB, GD, GE, GH, GM, HR, HU, ID, IL, IN, IS, JP, KE, KG, KP, KR, KZ, LC, LK, LR, LS, LT, LU, LV, MA, MD, MG, MK, MN, MW, MX, MZ, NI, NO, NZ, OM, PG, PH, PL, PT, RO, RU, SC, SD, SE, SG, SK, SL, SY, TJ, TM, TN, TR, TT, TZ, UA, UG, UZ, VC, VN, YU, ZA, ZM, ZW, ARIPO patent (BW, GH, GM, KE, LS, MW, MZ, SD, SL, SZ, TZ, UG, ZM, ZW), Eurasian patent (AM, AZ, BY, KG, KZ, MD, RU, TJ, TM), European patent (AT, BE, BG, CH, CY, CZ, DE, DK, EE, ES, FI, FR, GB, GR, HU, IE, IT, LU, MC, NL, PT, RO, SE, SI, SK, TR), OAPI patent (BF, BJ, CF, CG, CI, CM, GA, GN, GQ, GW, ML, MR, NE, SN, TD, TG)
 - as to applicant's entitlement to apply for and be granted a patent (Rule 4.17(ii)) for the following designations AE, AG, AL, AM, AT, AU, AZ, BA, BB, BG, BR, BY, BZ, CA, CH, CN, CO, CR, CU, CZ, DE, DK, DM, DZ, EC, EE, EG, ES, FI, GB, GD, GE, GH, GM, HR, HU, ID, IL, IN, IS, JP, KE, KG, KP, KR, KZ, LC, LK, LR, LS, LT, LU, LV, MA, MD, MG, MK, MN, MW, MX, MZ, NI, NO, NZ, OM, PG, PH, PL, PT, RO, RU, SC, SD, SE, SG, SK, SL, SY, TJ, TM, TN, TR, TT, TZ, UA, UG, UZ, VC, VN, YU, ZA, ZM, ZW, ARIPO patent (BW, GH, GM, KE, LS, MW, MZ, SD, SL, SZ, TZ, UG, ZM, ZW), Eurasian patent (AM, AZ, BY, KG, KZ, MD, RU, TJ, TM), European patent (AT, BE, BG, CH, CY, CZ, DE, DK, EE, ES, FI, FR, GB, GR, HU, IE, IT, LU, MC, NL, PT, RO, SE, SI, SK, TR), OAPI patent (BF, BJ, CF, CG, CI, CM, GA, GN, GQ, GW, ML, MR, NE, SN, TD, TG)
 - as to applicant's entitlement to apply for and be granted a patent (Rule 4.17(ii)) for the following designations AE, AG, AL, AM, AT, AU, AZ, BA, BB, BG, BR, BY, BZ, CA, CH, CN, CO, CR, CU, CZ, DE, DK, DM, DZ, EC, EE, EG, ES, FI, GB, GD, GE, GH, GM, HR, HU, ID, IL, IN, IS, JP, KE, KG, KP, KR, KZ, LC, LK, LR, LS, LT, LU, LV, MA, MD, MG, MK, MN, MW, MX, MZ, NI, NO, NZ, OM, PG, PH, PL, PT, RO, RU, SC, SD, SE, SG, SK, SL, SY, TJ, TM, TN, TR, TT, TZ, UA, UG, UZ, VC, VN, YU, ZA, ZM, ZW, ARIPO patent (BW, GH, GM, KE, LS, MW, MZ, SD, SL, SZ, TZ, UG, ZM, ZW), Eurasian patent (AM, AZ, BY, KG, KZ, MD, RU, TJ, TM), European patent (AT, BE, BG, CH, CY, CZ, DE, DK, EE, ES, FI, FR, GB, GR, HU, IE, IT, LU, MC, NL, PT, RO, SE, SI, SK, TR), OAPI patent (BF, BJ, CF, CG, CI, CM, GA, GN, GQ, GW, ML, MR, NE, SN, TD, TG)
 - as to applicant's entitlement to apply for and be granted a patent (Rule 4.17(ii)) for the following designations AE, AG, AL, AM, AT, AU, AZ, BA, BB, BG, BR, BY, BZ, CA, CH, CN, CO, CR, CU, CZ, DE, DK, DM, DZ, EC, EE, EG, ES, FI, GB, GD, GE, GH, GM, HR, HU, ID, IL, IN, IS, JP, KE, KG, KP, KR, KZ, LC, LK, LR, LS, LT, LU, LV, MA, MD, MG, MK, MN, MW, MX, MZ, NI, NO, NZ, OM, PG, PH, PL, PT, RO, RU, SC, SD, SE, SG, SK, SL, SY, TJ, TM, TN, TR, TT, TZ, UA, UG, UZ, VC, VN, YU, ZA, ZM, ZW, ARIPO patent (BW, GH, GM, KE, LS, MW, MZ, SD, SL, SZ, TZ, UG, ZM, ZW), Eurasian patent (AM, AZ, BY, KG, KZ, MD, RU, TJ, TM), European patent (AT, BE, BG, CH, CY, CZ, DE, DK, EE, ES, FI, FR, GB, GR, HU, IE, IT, LU, MC, NL, PT, RO, SE, SI, SK, TR), OAPI patent (BF, BJ, CF, CG, CI, CM, GA, GN, GQ, GW, ML, MR, NE, SN, TD, TG)
 - as to the applicant's entitlement to claim the priority of the earlier application (Rule 4.17(iii)) for all designations
 - as to the applicant's entitlement to apply for and be granted a patent (Rule 4.17(ii)) for the following designations AE, AG, AL, AM, AT, AU, AZ, BA, BB, BG, BR, BY, BZ, CA, CH, CN, CO, CR, CU, CZ, DE, DK, DM, DZ, EC, EE, EG, ES, FI, GB, GD, GE, GH, GM, HR, HU, ID, IL, IN, IS, JP, KE, KG, KP, KR, KZ, LC, LK, LR, LS, LT, LU, LV, MA, MD, MG, MK, MN, MW, MX, MZ, NI, NO, NZ, OM, PG, PH, PL, PT, RO, RU, SC, SD, SE, SG, SK, SL, SY, TJ, TM, TN, TR, TT, TZ, UA, UG, UZ, VC, VN, YU, ZA, ZM, ZW, ARIPO patent (BW, GH, GM, KE, LS, MW, MZ, SD, SL, SZ, TZ, UG, ZM, ZW), Eurasian patent (AM, AZ, BY, KG, KZ, MD, RU, TJ, TM), European patent (AT, BE, BG, CH, CY, CZ, DE, DK, EE, ES, FI, FR, GB, GR, HU, IE, IT, LU, MC, NL, PT, RO, SE, SI, SK, TR), OAPI patent (BF, BJ, CF, CG, CI, CM, GA, GN, GQ, GW, ML, MR, NE, SN, TD, TG)
 - as to inventorship (Rule 4.17(iv)) for US only
- Published:**
- with international search report
 - before the expiration of the time limit for amending the claims and to be republished in the event of receipt of amendments
- For two-letter codes and other abbreviations, refer to the "Guidance Notes on Codes and Abbreviations" appearing at the beginning of each regular issue of the PCT Gazette.

A SYSTEM AND METHOD FOR NEUROMUSCULAR REEDUCATION

BACKGROUND OF THE INVENTION

[0001] 1. Field of the Invention:

[0002] The present invention broadly relates to bio-monitoring in patients, and deals more particularly with a system and a method for implementing a protocol for restoring physical functions of the neuromuscular system through bio-feedback.

[0003] 2. General Background and State of the Art:

[0004] Many people have movement disabilities caused by disease or injury. Among the causes are cerebrovascular accident or stroke (CVA), traumatic brain injury, multiple sclerosis, spinal cord injury and Parkinson's disease. Stroke is the leading cause of disability in the United States with at least 700,000 new cases each year. Over half of these people have residual physical disability. Current stroke therapy is labor-intensive and costly. Often insurance does not cover the cost of full therapy. One estimate is that the United States spends \$30 billion per year to take care of stroke survivors. Seventeen billion dollars of this cost is direct medical expenditures and thirteen billion dollars represent an indirect cost due to lost productivity. Another estimate is that the total direct and indirect costs of stroke are \$43.3 billion per year. The number of strokes is projected to increase because of the increase in the over 50 "baby boom" population. Also, new pharmaceutical treatments for stroke are projected to increase the number of patients surviving a stroke and increase the percentage of stroke survivors requiring rehabilitation. Therefore, it is not surprising that a recent estimate indicates the prevalence of stroke will more than double over the next 50 years.

[0005] Following a stroke, the initial treatment is to stabilize the patient. This usually occurs in an emergency room and critical care unit. Following stabilization, the patient is typically transferred to a hospital rehab unit. The time in a rehab unit has been significantly reduced in recent years by the pressures of health care reimbursement but could be as much 14 days. Because of the reduced time, very little therapy aimed at restoring function is applied. Patient activities involve learning

toileting, transfers between locations and how to perform functions with the unaffected limb which reinforces learned non-use and hinders restoration of function of the affected limb. The level of disability and availability of health care funds determines where the patient goes following discharge from the rehab unit. The most severely afflicted go to a nursing home. Some patients receive comprehensive treatment in Day Treatment facilities, whereas some patients go to out-patient facilities for treatment of specific functional losses, while others receive home health treatment from visiting therapists.

[0006] Because of health care reimbursement reductions, therapy time for stroke patients has been significantly decreased. Currently, a majority of time spent in therapy post-stroke concentrates on helping a patient adapt to their disability by teaching toileting skills and transfers. A consequence of this treatment is the emergence of "learned nonuse" that hinders the restoration of available function. Most current rehabilitation therapies are administered on a spaced basis. Recently, concentrated therapies have been developed that improve function in CVA patients by reversing the effects of "learned nonuse". Animal studies suggest that learned nonuse is established immediately after the initial organic damage. A patient is punished for trying to use the affected limb and is rewarded for using other parts of the body. Over time, healing of the organic damage occurs but the suppression of use learned in the acute phase remains in force. Also, many of the therapies that have been shown to be effective in restoring function involve massed practice. Physical Therapy training techniques have been used by researchers. Significant improvement in limb function was obtained in chronic CVA patients.

[0007] Training techniques based on electromyographic (EMG) biofeedback improve motor ability of chronic CVA patients, as demonstrated by some studies. Repetitive concentrated practice produced large therapeutic effects for lower limb function. Researchers have also systematically studied a variation of forced use of hemiplegic extremities which has been labeled Constraint-Induced (CI) Movement Therapy. Some of these experiments compared several massed therapy techniques and all showed very large increases in limb use over the treatment period.

[0008] Two very sophisticated robot systems are being developed for treatment and evaluation of CVA patients which have shown some effectiveness in treatment of CVA patients and have developed very useful data for understanding recovery

mechanisms; however, the current cost of these systems precludes their widespread clinical use.

[0009] Other studies have shown that measured EMG can be used to trigger neuromuscular electrical stimulation in restoring function to CVA patients. However, the discomfort of surface neuromuscular stimulation significantly limits the clinical implementation of this modality for persons with hemiplegia. EMG biofeedback treatment of stroke patients has also shown some success. This treatment uses surface electrodes to capture the electrical activity of a selected muscle group. An electronic unit converts the signals into visual or audio information for the patient. This information is used by the patient to augment or decrease muscle activity.

[0010] Accordingly, what is needed is a system and a method that promotes the restoration of physical functions of the neuromuscular system by incorporating into one device, the treatment modalities of repetitive practice, and force and EMG biofeedback. Furthermore, the system should be inexpensive, portable, comfortable, and easy to use either by the patient or by a therapist.

INVENTION SUMMARY

[0011] The system according to the present invention will assist in therapy by supplying increased amounts of information to the physician/therapist while reducing the amount of patient contact time. The system is adaptable to accommodate the changing paradigm of cerebrovascular accident (CVA) rehabilitation service delivery and to assist in studies designed to refine therapy protocols.

[0012] Accordingly, in one aspect of the invention, the system for neuromuscular function reeducation and restoring physical function of a neuromuscular system, associated with a joint in a patient, includes at least one sensor for measuring an electrical signal associated with an agonist muscle in the neuromuscular system of the patient. The electrical signal associated with the agonist muscle is used to provide visual feedback for controlling the joint extension and flexion thereby enabling reeducation and restoration of the physical function of the neuromuscular system.

[0013] In another aspect of the invention, the system for neuromuscular function reeducation and restoring physical function of a neuromuscular system, associated with a joint in a patient, includes at least one sensor for measuring an electrical

signal associated with an agonist muscle in the neuromuscular system of the patient, at least one sensor for measuring an electrical signal associated with an antagonist resisting muscle. The electrical signal associated with the agonist muscle and the electrical signal associated with the antagonist resisting muscle are combined to form a net signal which is used to provide visual feedback for controlling the joint extension and flexion thereby enabling reeducation and restoration of the physical function of the neuromuscular system.

[0014] In another aspect of the invention, the system for neuromuscular function reeducation and restoring physical function of a neuromuscular system, associated with a joint in a patient, includes at least one sensor for measuring an electrical signal associated with an agonist muscle in the neuromuscular system of the patient, at least one sensor for measuring an electrical signal associated with an antagonist resisting muscle, at least one electrode for providing a low-level neuromuscular stimulation to the neuromuscular system. The electrical signal associated with the agonist muscle and the electrical signal associated with the antagonist resisting muscle can be viewed separately or combined to form a net signal which is used to provide visual feedback, the visual feedback and the low-level neuromuscular stimulation being used for controlling the joint extension and flexion thereby enabling reeducation and restoration of the physical function of the at least one neuromuscular system.

[0015] In another aspect of the invention, the system for neuromuscular function reeducation and restoring physical function of a neuromuscular system, associated with a joint in a patient, includes at least one continuous passive device for allowing the extension and flexion of the joint, wherein the continuous passive device permitting self-actuation of the neuromuscular system, at least one force sensor for measuring a parameter indicative of resistance of an antagonist resisting muscle, the antagonist resisting muscle associated with the neuromuscular system. The parameter which indicates the resistance of the antagonist resisting muscle is used for controlling the joint extension and flexion thereby enabling reeducation and restoration of the physical function of the at least one neuromuscular system.

[0016] In another aspect of the invention, the system for neuromuscular function reeducation and restoring physical function of at least one neuromuscular system, associated with an at least one joint in a patient, includes: (i) a motion causing

device adjacent to the joint, the motion causing device permitting self-actuation of the neuromuscular system; (ii) at least one force sensor for measuring a parameter indicative of the muscle resistance; (iii) at least one joint position sensor for measuring joint movement; (iv) at least one neuromuscular electrical stimulating (NMES) system; (v) an electronic memory system that stores information of the patient; (vi) at least one EMG sensor for measuring the electrical activity of the neuromuscular system; and (vii) a controller that implements a protocol for controlling the joint motion based on the measurements from the sensors thereby restoring physical function of the neuromuscular system associated with the joint.

[0017] In one embodiment of the present invention, the motion causing device could be an inflatable device, such as a pneumatic air-muscle, having two ends, wherein one end is connected to a distal element of the joint and the other end to a proximal element of the joint. Such a device has the property that increasing the diameter, by supplying pressurized air for it to inflate, causes it to shorten thereby causing the joint to pivot about at least one axis. Like human muscle, this device has spring-like characteristics, is flexible, and is lightweight. Moreover, the force-deflection characteristics can be made substantially similar to those of human muscle.

[0018] In conjunction with the system for neuromuscular function reeducation and restoring physical function of at least one neuromuscular system, the present invention includes a method for implementing a protocol for restoring physical function of the neuromuscular system associated with an at least one joint in a patient. This method comprises: (i) measuring a first signal indicative of the activity of a muscle, in the neuromuscular system, through an EMG sensor; (ii) measuring a second signal indicative of the joint motion through a joint position sensor; (iii) measuring a third signal indicative of the muscle resistance through a force sensor; (iv) mapping the measured signals to at least one parameter; and (v) controlling the air level in an inflatable device (such as the pneumatic air-muscle) in order to optimize the parameter for restoring physical function of the muscle, in the neuromuscular system, associated with the joint in the patient.

[0019] Furthermore, although repetitive task practice therapies have been shown to be effective, a significant number of stroke survivors have insufficient hand motion to participate fully in these activities. Studies have shown that the Tonic Vibration

Reflex (TVR) lowers recruitment thresholds of agonist muscle groups and inhibit activation of antagonistic muscle groups. This tonic reflex mechanism of the agonist muscle is stimulated by prolonged vibration of its tendon. These trains of vibration to a tendon of a receptor-bearing muscle stimulate human spindle primary afferents which cause autogenetic muscle contraction. For example TVR activation of wrist and finger muscles can be used to enhance the motion and functionality of stroke patients that have high flexor muscle tone and low extensor motion. Thus another aspect of the invention incorporates a vibrator to stimulate the TVR.

[0020] Thus, in another aspect of the invention, the system for neuromuscular function reeducation and restoring physical function of a neuromuscular system, associated with a joint in a patient, includes at least one sensor for measuring an electrical signal associated with an agonist muscle in the neuromuscular system of the patient, at least one sensor for measuring an electrical signal associated with an antagonist resisting muscle, at least one vibrator to excite the TVR. The electrical signal associated with the agonist muscle and the electrical signal associated with the antagonist resisting muscle can be viewed separately or combined to form a net signal which is used to provide visual feedback, the visual feedback and the low-level neuromuscular stimulation being used for controlling the joint extension and flexion thereby enabling reeducation and restoration of the physical function of the at least one neuromuscular system.

[0021] The above and other objects, features, and advantages of the present invention will become apparent from the following description read in conjunction with the accompanying drawings.

BRIEF DESCRIPTION OF THE DRAWINGS

[0022] FIG. 1 shows one embodiment of the motion causing device, which is the air-muscle described herein, attached to the proximal forearm along with various sensors and a controller box;

[0023] FIG. 2 depicts an exemplary procedure for attaching EMG electrodes for measuring joint extensor activity;

[0024] FIG. 3 shows one embodiment of the motion causing device, which is the air-muscle described herein, in at least two operational modes, namely the deflated mode and the inflated mode which flexes and extends, respectively, the wrist joint;

[0025] FIG. 4 shows another embodiment of the motion causing device, which is the air-muscle described herein permitting the wrist joint to be in flexion, neutral, and extended position respectively;

[0026] FIG. 5 is a block diagram showing one embodiment of the present system for neuromuscular function reeducation and restoring physical function of at least one neuromuscular system;

[0027] FIG. 6 shows the pivot points and trajectory taken by the motion causing device, such as an air-muscle, according to one aspect of the present invention;

[0028] FIG. 7 shows the pivot points and trajectory taken by the motion causing device, such as an air-muscle, according to another aspect of the present invention;

[0029] FIG. 8 is a flow chart depicting one embodiment for the protocol for neuromuscular function reeducation and restoring physical function of at least one neuromuscular system;

[0030] FIG. 9 is one embodiment of the invention using a continuous passive motion (CPM) device in conjunction with an air-muscle device;

[0031] FIG. 10 is an alternative embodiment, with reduced linkages, showing the pivot points and trajectory taken by the air-muscle;

[0032] FIG. 11 is yet another embodiment, with reduced linkages, showing the pivot points and trajectory taken by the air-muscle;

[0033] FIG. 12 is an initial state of the air-muscle device used in conjunction with a robotic system for providing assistive training;

[0034] FIG. 13 is an intermediate state of the air-muscle device used in conjunction with a robotic system for providing assistive training;

[0035] FIG. 14 is a final state of the air-muscle device used in conjunction with a robotic system for providing assistive training; and

[0036] FIG. 15 is an exemplary plot depicting the torque calibration curves for two strap conditions.

DETAILED DESCRIPTION OF THE PREFERRED EMBODIMENTS

[0037] Referring now to the drawings and in particular to FIG. 1, there is shown motion causing device or an actuator 10 attached to the proximal forearm 12 along

with various sensors **14**, **15** for monitoring activity along the proximal forearm **12** and the at least one joint **16**, at least one electrostim electrode **22** for providing a low-level neuromuscular stimulation, and a controller box **18** with a display port **20** for providing visual feedback for a patient/therapist. The system shown in FIG. **1** is used for neuromuscular function reeducation and restoring physical function of at least one neuromuscular system.

[0038] It is important that the actuator **10** permit relative motion between the proximal and distal portions of the joint **16** in a manner to minimize any hindrance or interference with any motion generated by the patient's neuromuscular system.

[0039] In one embodiment, the actuator **10** is a pneumatically operated air-muscle. A prior art artificial muscle device exhibits many of the properties of human muscle. The artificial muscle device consists of an expandable internal bladder (e.g., a rubber tube) surrounded by a braided shell. When the internal bladder is pressurized, it expands radially against the braided shell causing the muscle to contract. Braided finger traps used to hold fingers on traction devices contract radially when pulled. The air-muscle, according to one embodiment in the present invention, works in the same manner but in the opposite direction (i.e., increasing the diameter causes it to shorten). Like human muscle, the device has spring-like characteristics, is flexible, and is lightweight. The force-deflection characteristics can be made similar to those of human muscle. Pressurized air canisters or accumulators that are recharged by air compressors can be used as a source for supplying air to the air-muscle. Major advantages of the air muscle are its flexibility and ease of adaptation to address the specific loss of function exhibited by a patient. Additionally, the device of the preferred embodiment has three times the pull force of an air piston of the same cross sectional area. The utility of this device resides in its unique combination of attributes: low cost, light-weight, low profile, and low noise operation.

[0040] The sensors include at least one joint position sensor **15** for measuring joint movement, at least one force sensor **48** (shown in FIG. **5A**) for measuring a parameter indicative of the muscle resistance, at least one EMG sensor **14** for measuring the electrical activity of the neuromuscular system. Furthermore, there is at least one neuromuscular electrical stimulating (NMES) device, such as an electrostim electrode **22**, for providing low-level neuromuscular stimulation.

[0041] The controller box **18**, connected through cable **24** to the air-muscle **10**, includes electronics (i) for recording and displaying **20** measurements obtained through various sensors **14**, **15**, and (ii) for controlling the air-muscle **10** operation (e.g., by controlling the supply of air into the muscle). This controller box **18** is a self-contained, mobile device that provides sensory (e.g., visual) feedback of wrist and finger position, EMG extensor activity and wrist flexor resistive torque. Alternatively, the sensory feedback could be provided through tactile sensing through piezoelectric transducer induced vibrations on the skin, or through audio signals (e.g., beeps through an auditory display). The firmware in the microprocessor of the controller system **18** has been designed to be well-structured using object-oriented programming techniques. Use of these techniques yields more reliable code having fewer discrepancies and problems. The controller box **18** is shown as a separate device, however it is to be understood that the box could be a sleeve wrapped around the arm of a patient and as shown in FIG. 2.

[0042] FIG. 2 depicts an exemplary procedure for attaching at least one EMG electrode **15** for measuring joint extensor activity (also known as the agonist muscle activity). Closely spaced surface electrodes are used to measure joint extensor EMG activity. The location of the EMG electrodes **15** is determined for each patient by the therapist. The skin may be rubbed several times with alcohol soaked gauze pads. The EMG electrode output is used to measure the relative recruitment of selected extensor muscles and may be used to feedback the information to the patient to reinforce correct recruitment. Session to session variation in EMG values may be recorded for monitoring patient performance and/or compliance. The EMG sensor may be used for measuring the electrical activity of an agonist muscle (e.g., the extensor muscle) and/or an antagonist resisting muscle (e.g., the flexor muscle) in the neuromuscular system of a patient. Two measuring channels may be used to capture EMG activity of the muscle sets of the neuromuscular system.

[0043] The air-muscle is supplied by compressed air by means of a source (FIG. 5, **42**), and the air supply may be controlled by the controller **18** that includes a microprocessor (FIG. 5B) for controlling at least one valve (FIG. 5C, **46**) that controls the supply of pressurized air to the air-muscle.

[0044] In one embodiment of the present invention, as shown in FIG. 3, one end of the air-muscle **10** is connected to a distal element **34** of the wrist joint **16** and the

other end of the air-muscle **10** is connected to a proximal element **32** of the wrist joint **16**. Activation of the air muscle **10**, by inflating it through a supply source **42** (Fig. **5C**) of air, may cause the joint to pivot about at least one axis and causing the joint to go from a flexed position to the extended position as shown in FIG. **3**. As an example, this could be achieved by means of rotation of a bar that extends the wrist and operates a mechanism that extends the fingers and wrist between a flexed, neutral, and extended positions as shown in FIG. **4**. An optional data port **36** may be provided for downloading stored information from the memory **50** (FIG. **5**) of controller **18** to a PC (not shown).

[0045] Now referring to FIG. **4**, an alternative embodiment of the present invention is shown therein. Specifically, the wrist joint is shown in three states (flexion, straight, and extended). The air-muscle device **10** (shown with a braided type covering), having strap **330** for permitting air from a source **42**, is connected at one end to the forearm support structure **300** via connector **326**. The support **300** wraps around the forearm and is held in place by means of straps **322**. The other end of the air-muscle **10** is connected to a bar **324** which also provides a pulley for the extension strip **336**. One end **320** of the strip **336** is connected to a bar **338** with a corresponding joint **332**. The other end of strap **336** is attached to the support structure **300**. The joints, **342** and **340**, of the support structure **300** are positioned substantially adjacent the knuckles **344** and the finger joints **346**, respectively, of the patient's hand. The structure **300** may also include tubes **352** for allowing the finger ends to be housed.

[0046] With regards to the operation of the device in FIG. **4**, shown therein are three states that the wrist joint may achieve: (i) flexion, (ii) normal, and (iii) extension. Clearly, the device permits a very high number of states intermediate to the states shown in FIG. **4**. The air-muscle **10** extends, relatively, in length, upon deflation (as shown in the top figure of FIG. **4**), which causes the bar **338** to rotate/pivot clockwise (looking from the top and as depicted by the arrow **400**) about joint **310**. This causal effect is established by means of the strip **336** that connects the bar **338** to the air-muscle **10**. This pivot action of the bar **338** causes the wrist to achieve the flexion state. Furthermore, rotation of the joints **342** and **340** may allow the knuckle joints and the finger joints to assume curled/retracted positions.

[0047] The air-muscle 10 shortens, relatively, in length, upon reasonable inflation (as shown in the middle figure of FIG. 4), which causes the bar 338 to rotate/pivot counter-clockwise (looking from the side and as depicted by arrow 420) about joint 310. This causal effect is established by means of the strip 336 that connects the bar 338 to the air-muscle 10. This pivot action of the bar 338 causes the wrist to achieve the normal or straight state. Furthermore, rotation of the joints 342 and 340 may allow the knuckle joints and the finger joints to assume substantially straightened positions.

[0048] The air-muscle 10 shortens, relatively, much more in length, upon a higher degree of inflation (as shown in the bottom figure of FIG. 4), which causes the bar 338 to further rotate/pivot counter-clockwise (looking from the top and as depicted by the arrow 440) about joint 310. This causal effect is established by means of the strip 336 that connects the bar 338 to the air-muscle 10. This pivot action of the bar 338 causes the wrist to achieve the extension state. Furthermore, rotation of the joints 342 and 340 may allow the knuckle joints and the finger joints to assume substantially extended positions.

[0049] Joint extension position or displacement is measured by the at least one joint position sensor 15, such as a potentiometer, that is incorporated in the motion causing device. Resistance to extension, that may be due to the antagonist resisting muscle, is measured by the at least one force sensor 48 (FIG. 5A), such as a force sensitive resistors (FSRs), that is placed on the device. The FSR output is a measure of the resistance of finger and wrist flexor muscles. Alternatively, the resistance to extension may be measured by at least one EMG sensor. Alternatively, the resistance to extension may be determined by measuring the maximum extension of a patient's hand under a specified activation pressure. The compliant property of the air muscle allows the lack of full extension to be calibrated versus the resisting load or torque.

[0050] If force sensors are used, the at least one force sensor 48 (i.e., the FSR) is calibrated after each device is assembled. A load cell (not shown) is inserted between an activation bar on the device and muscle. The mechanism is fixed in six different degrees of flexion-extension. The output of the FSR may be compared to the load cell output. The torque about the joint at each wrist position is calculated by multiplying the muscle force by the distance to the line of action of the air muscle.

[0051] As mentioned above in paragraph 44, the force sensing aspect may be simplified by simply measuring the performance of the air muscle. Specifically, when the air muscle is pressurized, external loads cause it to extend. Thus, the amount of extension caused by the resistance of spastic resisting muscles may be sufficiently large to be measured with the joint position potentiometer. The calibration of the amount of lengthening of the muscle may be achieved by determining the change in joint position potentiometer reading versus the resistive load. This calibration result may then be stored in the microprocessor. When the hand is extended by a prescribed pressure, the amount by which the extension motion is reduced from full extension is a measure of the resisting torque.

[0052] In another aspect of the invention, protection against overloading a limb is provided by the compliant nature of the pneumatic muscle. Because of this compliance, it may not be necessary to provide an auxiliary exhaust if excessive resistance is encountered. The compliance also provides a method of measuring the resistive load, as confirmed through Mentor testing by means of a load cell inserted between the air muscle and the actuating bar of the hand mechanism. A data acquisition system recorded the load and the position as measured by the pivot potentiometer at 100 Hz. Resistive forces were generated by hanging weights on the hand piece and also by wearing the Mentor and manually resisting the motion with different levels of force. The resistive load versus the amount of extension is shown in FIG. 15. After one set of resistive measurements was made, the initial tightness of the strap connecting the bar to the load cell and the muscle was adjusted. The load versus amount of extension is linear but is a function of the adjustment of the strap. Based on these results, the force sensing was changed from force sensitive resistors (FSRs) to measuring the decrement from full extension. The load-rotation calibration of each Mentor is determined at the completion of assembly. These measurements also determine the rate of extension.

[0053] The motion causing device 10 (i.e., the air-muscle) drives the fingers and wrist into extension by moving a mechanical linkage. The linkage is designed to move the fingers and/or wrist in a spiral fashion. A therapist can also program the air-muscle(s) so that a desired motion pattern is followed for fastest and effective recovery.

[0054] Additionally, excessive force on the hand is prevented in several ways. A micro-compressor was chosen that has a maximum output pressure which limits the maximum force supplied by the air muscle. The air muscle is a very compliant drive with the maximum force output at the fully flexed position where the stretch reflex resistance of the flexor muscles is minimum. As extension proceeds, the stretch reflex increases resistance to motion. If a large resistance is encountered during extension, the air muscle stretches and limits the range of motion. Since spastic flexor muscles are velocity sensitive, the velocity of actuation was chosen to be about 5 degrees per second with no loading. With the weight of a flaccid hand this rate decreases to about 3.8 degrees per second and with mild resistance the rate is approximately 2.7 degrees per second. Previous experiments have shown only small increases in muscle tone occurring for very spastic hemiplegics due to velocity at rates below about 6 degrees per second. The rate in the present device is physically controlled by the volume capacity of the micro-compressor and the resistance in the pneumatic circuits. To prevent excessive extension of the wrist, a physical stop may be provided that limits motion of the activation bar at about 60 degrees of wrist extension. A safety panic switch that releases the air pressure is also provided on a tether and is placed close to the patient's side.

[0055] An important aspect for choosing the actuator to be an air-muscle is that the air-muscle permits relative motion between the proximal and distal portions of the joint, due to its high mechanical compliance, in a manner that does not hinder or interfere with any motion generated by the neuromuscular system. Allowing self-actuated motion of the joint by means of the neuromuscular system is an important element in the design. Specifically, the air-muscle allows unfettered self-actuated motion of the joint.

[0056] In another aspect of the invention, a continuous passive device, with a high mechanical compliance, that permits extension and flexion of the joint through self-actuation could be used for neuromuscular function reeducation and restoring physical function of the neuromuscular system.

[0057] FIG. 5 is a block diagram showing one embodiment of the present system for neuromuscular function reeducation and restoring physical function of at least one neuromuscular system showing the controller 18 with a microprocessor 44 and an electronic memory 50, the air-muscle 10, at least one display 20, at least one joint

position sensor **15**, at least one force sensor **48**, at least one EMG sensor **14**, at least one neuromuscular electrical stimulation (NEMS) device **22** for providing low-level neuromuscular stimulation. The real-time clock/calendar **52** is powered by a battery mounted on the printed circuit board when the power is off. The clock **52** maintains the time and date continuously. Records of patient use, active range of motion, extensor resistive torque, and EMG activity are recorded with a time stamp in a non-volatile serial EEPROM memory device **50**. Data is kept safe, even when no power is applied to the memory **50**. These records can be downloaded to a therapist's or patient's personal computer. A patient record can be printed that provides a performance history and compliance by date. A display **20** is made available for viewing and monitoring joint/muscle activity during therapy.

[0058] The microprocessor **44** controls the activation of the air muscle by operating the microcompressor and/or the air valves. Wrist/joint position may be displayed as a bar graph or as numbers on the LCD display **20**. The degree of flexor resistance torque measured by the at least one force sensor, and/or electrical activity from the EMG sensor may be displayed as a variable length line of lit light emitting diodes (LEDs) incorporated next to the LCD display **20**. The changing goal for active wrist motion may be displayed as a line on the LCD graph. One line of multi-color light emitting diodes (LEDs) may indicate the degree of flexor resistance torque as measured by the force sensitive resistors. A second line of LEDs may indicate the EMG activity of the wrist or finger extensors. The microcompressor, air valves, microprocessor, and the LCD may be portably located on or beside the patient during therapy sessions. Alternatively, feedback may be provided to the patient/therapist through audio signals (e.g., by varying the tonal frequencies, amplitudes, etc.). Records of patient use, active range of motion, extensor resistive torque, and EMG activity are recorded with a time stamp in an electronic memory device (e.g., a non-volatile serial EEPROM). The electronic memory system can provide stored information, such as patient compliance and patient performance, from the electronic memory to a therapist/patient on command. Thus, the system includes a mechanism for the patient to monitor the compliance and performance through visual and possibly aural means. Moreover, the controller may update the displays in a predetermined manner to provide a mechanism for the patient to

improve performance and compliance for neuromuscular function reeducation and for restoring physical function of the neuromuscular system in the patient.

[0059] The present invention provides neuromuscular reeducation and restoration of physical function of the neuromuscular system in the patient through (1) biofeedback, (2) repetitive task practice, and (3) neuromuscular electrical stimulation (NMES). Furthermore, psychological research has shown that an important part of biofeedback stimulated neuromuscular reeducation is shaping, which is defined by psychologists as establishing goals just beyond current capability and changing goals as progress is made. The present invention also provides shaping through measurements obtained during therapy session. Additionally, research has shown that many repetitions are necessary for permanent neuromuscular reeducation. To encourage practice of the repetitions, the present invention records compliance of a patient with the repetitive therapy and provides a report back to the patient's therapist.

[0060] One method for implementing a protocol, for the system as described, for restoring physical function of the neuromuscular system comprises measuring a signal indicative of the activity of the muscle through the EMG sensor(s) **14**; measuring a signal indicative of the joint motion through a joint position sensor **15**, where the joint is associated with the neuromuscular system; measuring another signal indicative of the muscle resistance through the force sensor **48**; mapping the measured signals to at least one parameter; and controlling the air level in the air-muscle **10** in order to optimize the parameter for restoring physical function of the neuromuscular system associated with the joint in the patient.

[0061] FIGs. **6**, **7** depict one arrangement of pivot points **60** and linkages **64** associated with the air-muscle **10** attached to forearm supports (as depicted by **62**). The air-muscle **10**, upon inflation and deflation, permits the arm and joints to achieve pre-determined trajectories (shown as spiral type in the figures). Hence, the pivot point **60** positions and the trajectories of the arm (or linkages **64**) can be controlled by inflating/deflating the air-muscle **10** in a manner to get optimal motion for the arm and joint thereby providing means for effective restoration of the physical function of the neuromuscular system. For example, in FIG. **6**, the air muscle **10** is shown connected at one end to the forearm support **62** while at the other end it is depicted as being attached to pivot point or driving point **60**. When the air-muscle **10** is

inflated/deflated in a specific manner optimal motion is achieved for reeducation and restoration of the neuromuscular system.

[0062] In an alternative embodiment, as depicted in FIGs. 10, 11, there is a reduction in the number of linkages (over the embodiment of FIGs. 6, 7) but the muscle is still able to achieve the same trajectory and motion.

[0063] FIG. 8 is a flow chart depicting another embodiment of the protocol for restoring physical function of the neuromuscular system. Specifically, the patient is instructed to try to extend the wrist when a beep is heard. The EMG activity of the wrist extensors and the motion of the wrist are recorded in the memory of the device and displayed for the patient. The patient could be instructed to use the device for 6 hours a day, although more usage may be allowed, and the treatments need not be continuous. The patient could start and stop the device at any time. The first 2 hours could focus on EMG and joint position feedback. During the second 2 hours the flexor resistance torque from the flexors could be used as the feedback signal to help the patient reduce any flexor spasticity. The final 2 hours of therapy would include both extensor EMG and flexor resistance torque as feedback. The number of completed cycles could be recorded for each day as well as the time for each cycle and the total treatment time for each day. The patient could be encouraged to grasp a block and lift it several times during a day and at the end of each therapy session. After grasping, the patient may be encouraged to try and lift and subsequently move the block. The patient may also be encouraged to keep a record of successful attempts.

[0064] In the protocol, the level of extensor EMG activity may be indicated by LEDs on the display 20. A level equal to that obtained at the last clinic therapy session would show as a yellow light. A level below would generate a buzzing sound. A green LED would indicate a higher level. Faster flashing LEDs indicate higher levels of EMG activity. The output of the joint position sensor is displayed on the LCD by a bar. If motion exceeds this line a pleasant sound is heard. After every day, the line that represents the goal could be increased/updated by a certain amount (e.g., 1% of the highest joint motion achieved in the previous day). Thus, joint position could serve as the basis for subsequent training each day.

[0065] During training, whenever motion has stopped for a certain period (e.g., 3 seconds), the air- muscle could be activated and the wrist and finger extension may be completed. The extension could be held for a certain amount of time (e.g., 3 seconds) and then released. The torque of the flexor resistance is measured and displayed on flashing red LEDs during the process (the higher the force, the faster the blinking). The patient could be instructed to try to minimize this force by thinking about relaxing the flexors. A system delay (for e.g., of about 10 seconds) may be introduced and the process would be started over with an auditory beep.

[0066] The number of hours of operation of the device and the active motion achieved at the beginning of a day and at the end of each day may be recorded in memory. This information would provide fairly accurate information about patient compliance and permits matching of timed data from patient reports of self-documentation of training. When the device is turned on for the first time each day, these parameters are displayed for the patient on the LCD.

[0067] The memory may be downloaded onto a PC in the clinic. A summary chart graphically displaying the number of hours of use a day by the patient, the range of motion change per day and the change of active range of motion day to day may be displayed and the charts printed for the patient file.

[0068] In another aspect for providing therapy to a patient, the therapist can prescribe the patient as to how much time he or she can spend on a specific program. In essence, the amount of emphasis on each program depends on the symptoms of the patient. For example, the program could require work on the extensor muscle recruitment. To this end, the extensor EMG signal may be displayed as a line of LED lights on a relative scale. Alternatively, a single color coded or intensity coded LED could be used. The range between the minimum and maximum signal measured may be about 60% of the height of the LED line. Messages may be provided on the LCD display 20 to encourage the patient to increase the display level.

[0069] A second program, that could be selected by the patient, includes measurement of the resistance offered by the flexor muscles (antagonist resisting muscles) to an extension process. It is common for patients with neuromuscular diseases to develop a constant muscle contraction. Specifically, the flexors are

substantially stronger than the extensors which causes the characteristic flexed fingers and wrist that can be seen in many patients. The reason for this is the lack of inhibition present in the central nervous system. To retrain the neuromuscular system, the program could display the relative magnitude of the measured resistance and request the patient to consciously try and reduce the signal on the display. EMG sensors **14** located adjacent the flexor muscles and/or FSRs **48** or lack of full extension may be used for measuring the resistance. The program may also require the patient to extend the wrist with the air muscle to about neutral position. At this point EMG activity or the force output of the FSRs may be measured for the flexor muscles (antagonist resisting muscles). Subsequent calculation of the active stiffness generated by the flexors may be achieved by dividing the measured force by the amount of joint displacement (as measured by the potentiometer **15**).

[0070] A third program that can be selected for the patient permits (i) increasing the activity of the extensors, and (ii) simultaneously decreasing the activity of the flexors. The signal to one of the LED lines may be a combination of the magnitude of the extensor signal, and the flexor signal as measured either via the EMG sensor **14** or the FSR **48**. The patient may be asked to extend their fingers and wrist and then to think about their forearm so as to minimize the signal displayed via the LED lines.

[0071] It is well established that continuous passive motion entails inducing movement of certain limbs/joints without requiring muscle co-ordination, strength, or control by a patient. Numerous studies have shown that CPM of the different limbs and joints accelerates healing, and importantly results in a fuller range of motion of the joint at the end of the course of the therapy.

[0072] Thus, in another aspect of the system **200**, as shown in FIG. 9, a continuous passive motion (CPM) device **204**, in conjunction with an air-muscle device **206** and **206'**, may be used for providing flexion and extension to the joint **208** of the patient for reeducation and restoration of the physical functions of the neuromuscular system in a patient. During extension, the upper air-muscle device **206** may be controllably activated, whereas during flexion, the lower air-muscle device **206'** may be controllably activated. By providing a controlled activation of the air-muscle device in the CPM, it is possible to provide reeducation and restoration of the neuromuscular system.

[0073] In another embodiment of the present invention the air-muscle is modified so that it is capable of interacting with a personal computer based virtual reality program for capturing the interest of the user. The resulting system allows extension of the existing wrist/hand device through coordinated elbow and shoulder motions.

[0074] A prerequisite for the elaborate movements of the upper extremity, lower extremity gait, and dexterous abilities of humans in general is the ability to coordinate multiple joints and regulate forces produced by limb segments. Research data indicate that patients with stroke exhibit deficits in the ability to precisely control forces produced. However, with the air-muscle device, the inventors have found that this therapy improves patients' ability to control grasping forces during a general force-tracking task and a functional task (e.g. turning a key in a lock).

[0075] While the disturbance of voluntary upper extremity movement in patients with stroke is typically apparent upon visual examination, little is known about the mechanisms responsible for these disturbances due in part to the dearth of quantitative studies of multi-joint movements in such patients. During a target-directed pointing task, patients with stroke could reach into all parts of the workspace with their affected limb, suggesting that movement planning was intact for these patients. However, when inter-joint coordination was assessed by expressing elbow angle as a function of shoulder angle, patients with stroke exhibited an irregular and variable relationship. This disruption in inter-joint coordination resulted in movement paths that were more segmented and variable. It has been shown that prehension (reaching and grasping) movements of patients with stroke were characterized by a spatiotemporal dyscoordination between the arm and trunk. As a result, patients developed a new pattern of coordination represented by more trunk recruitment during prehensile actions. More recently, a kinematic analysis of reaching movements of patients with stroke indicated that patients with stroke, unlike healthy controls, recruited the trunk to assist in transporting the hand to the object. Thus, these patients were recruiting a new degree of freedom (e.g. the trunk) to perform this task. Further kinematic studies have shown that patients with stroke have a more variable: reaching path, orientation of the hand relative to the object, final hand position on the object, and a disruption in inter-joint coordination. These data suggest that patients with stroke have difficulty with motor execution. Therefore

rehabilitation of the affected upper extremity with the air-muscle is oriented toward restoring the normal sensorimotor relationships between the joints.

[0076] A consistent factor in laboratory and clinical studies of neuroplasticity is that to obtain reorganization of the neural system, cognitive input must be present and many repetitions are required. Also, studies have shown that concentrating on the effects of their movement rather than specific body movements enhances the effect. In other studies, there is some evidence that training in only one or two coordinated movements transfers to improvements in other tasks.

[0077] Therefore for the upper extremity, the therapeutic protocol chosen, for exemplary purposes according to one aspect of the invention, is to focus on two important tasks; reaching and eating. Specifically, the patient is requested to achieve either a reaching task or an eating task. After the patient has achieved his/her maximal motion, the device assists the limb to complete the task. Feedback of self-actuated progress is recorded and fed back to the patient.

[0078] In summary, a critical review of rehabilitation approaches to reduce impairments and improve upper extremity mobility among patients following stroke would lead to the conclusion that repetitive task practice incorporating biofeedback strategies can improve functional and mobility of patients with chronic stroke. When one adds to the growing limitations on treatment time, it seems reasonable to speculate that treatments emphasizing repetition of functionally-related tasks, performed in the home environment could enhance function and improve health related quality of life. This earlier relocation for centralization of stroke therapy into the home appears effective in promoting motor and functional gains while yielding substantial patient satisfaction. Complementing this approach through inclusion of devices that reinforce the need for volitional activation of joint movement while concurrently offering knowledge of results about range of motion, muscle activity or resistance to movement could be beneficial if such devices were reliable, easy to use, cost-effective, and conducive to home and clinical use.

[0079] FIGs. 12-14 shows various states of the air-muscle device used in conjunction with a robotic system for providing assistive training. The design philosophy is such that it encourages volitional activation of joint movement through feedback range of motion, muscle activity and resistance to movement and then

completing the task for the patient. In one aspect, for exemplary purposes, the system is adapted to provide training of two tasks (viz., feeding and reaching). It is anticipated that training of coordinated joint movement for these two tasks will lead to more general improvement in related functional tasks as found in other feedback therapies.

[0080] To train for the reaching motion, the robot system abducts the shoulder in the flex direction, extends the elbow, supinates the forearm, and extends the wrist and fingers. Training begins with the patient facing a table with her/his forearm resting on the table transverse to the torso (in a plane parallel to the frontal plane) as shown in FIG. 12. In one aspect of the invention, the shoulder motion is restricted to flexion in the sagittal plane. Thus, the intermediate reaching position is shown in FIG. 13.

[0081] To train for an eating motion, the robotic system flexes the shoulder, supinates the forearm, and extends the wrist as shown in FIG. 14. Most stroke patients have the ability to flex their elbow, so this function may be left to the patient. The assisted movements may be made in a slow manner to protect against significant increases in muscle tone.

[0082] Thus, as shown in the FIGs. 12-14, the air muscle 500 rotates the shoulder in abduction and flexion. A plastic hinge 502 only allows motion in the sagittal plane. The normal internal rotation of the humerus is held in neutral by the distal and proximal strapping system. The proximal air muscle rides on a plate 504 that rotates about the center of rotation of the humerus. A foam-lined sub-plate 506, that is attached to the torso with Velcro straps, distributes the vertical reaction of the air muscle. A plastic cuff 508 is attached to the upper humerus with Velcro straps. This serves as an attachment point for a driver 510 that is connected at its other end to the sliding plate that rests on top of the sub-plate. Contraction of the air muscle rotates the upper plate 504 in an arc about the center of rotation of the humerus. A potentiometer (not shown) centered on the axis of rotation records the amount of shoulder motion.

[0083] To control elbow motion, a hinge (not shown) is attached at the elbow with straps to the distal humerus and proximal forearm. A potentiometer is contained in the center of rotation of the hinge to measure elbow flexion and extension. The

forearm piece 512 has an extension 514 that is used an attachment point for an air muscle. The proximal end of this air muscle is attached to the center of rotation of the humerus.

[0084] Supination/pronation, plus coordinated extension of the wrist and fingers is obtained by a modification of the wrist/hand device that has been clinically tested and currently is in commercial distribution. Two muscles are attached to the hand/wrist device. The proximal end of one is attached to the inside of the forearm at the elbow and the other proximal end of the other one is attached to the outside of the forearm at the elbow. If the latter muscle is contracted, combined wrist and finger extension occurs along with supination of the forearm. If the other muscles contracts, combined wrist and finger extension occurs along with pronation of the forearm. A potentiometer is located at the center of rotation of the wrist. Initially, no measurement of pronation/supination will be included.

[0085] The above described system and programs thus provide effective and easy to use functionality for reeducation and restoration of the physical functions of the neuromuscular system in a patient. The system is inexpensive, portable, comfortable, and easy to use either by the patient or by a therapist.

[0086] In summary, the system and method according to the present invention is a self-contained, mobile device, implementing a protocol, and which provides visual and/or aural feedback of wrist and finger position, measurement of extensor and flexor activity for neuromuscular function reeducation and restoring physical function of at least one neuromuscular system in a patient.

[0087] The attached description of exemplary and anticipated embodiments of the invention have been presented for the purposes of illustration and description. They are not intended to be exhaustive or to limit the invention to the precise forms disclosed. Many modifications and variations are possible in light of the teachings herein. For example, a suitable inflatable device or mechanical drive can be used in replacement for the air-muscle. Additional sensors could be used for measuring critical parameters for restoring physical function. Multiple motion causing devices could be simultaneously connected at various positions on the patient's body, and the devices could be controlled by multiple or single controllers. Also, there could be a single display configured to provide feedback on several different measured

parameters. The therapist could be allowed to select, from a menu provided through the display, unique therapeutic protocol(s) for a specific patient. Furthermore, the frequency of patient use and the ability to reach performance goals can be recorded in memory and the record played back for the therapist/patient. While the specification describes particular embodiments of the present invention, those of ordinary skill can devise variations of the present invention without departing from the inventive concept.

We Claim:

1. A system for neuromuscular function reeducation and restoring physical function of an at least one neuromuscular system associated with an at least one joint in a patient, the system comprising:

at least one sensor for measuring a signal indicative of a force associated with the antagonist resisting muscle system in the neuromuscular system of the patient;

wherein the signal from the antagonist resisting muscle system is used to provide sensory feedback for affecting the joint extension and flexion, through the patient's cognitive action, thereby enabling reeducation and restoration of the physical function of the at least one neuromuscular system.

2. The system according to claim 1, wherein the at least one sensor for measuring a signal indicative of a force associated with the antagonist resisting muscle system is a force sensitive resistor (FSR).

3. The system according to claim 1, wherein the sensory feedback includes at least one of tactile sensing, audio signal, and light from a source.

4. The system according to claim 1, wherein the antagonist resisting muscle system is the flexor muscle system.

5. The system according to claim 1, wherein the signal indicative of the force associated with the antagonist resisting muscle system is related to the magnitude of resistance offered by said antagonist resisting muscle system.

6. The system according to claim 5, further including a joint position sensor for measuring the joint displacement.

7. The system according to claim 6, wherein the magnitude of the resistance is computed by dividing the force obtained from the force sensing system by the displacement as measured by the joint position sensor.

8. A system for neuromuscular function reeducation and restoring physical function of an at least one neuromuscular system associated with an at least one joint in a patient, the system comprising:

at least one sensor for measuring an electrical signal associated with an agonist muscle in the neuromuscular system of the patient;

at least one sensor for measuring a force signal associated with an antagonist resisting muscle;

wherein at least one of the electrical signal associated with the agonist muscle and the force signal associated with the antagonist resisting muscle is used to provide sensory feedback for affecting the joint extension and flexion thereby enabling reeducation and restoration of the physical function of the at least one neuromuscular system.

9. The system according to claim 8, wherein the sensory feedback is provided through an audio signal.

10. The system according to claim 8, wherein the at least one sensor for measuring an electrical signal associated with the agonist muscle is an EMG sensor.

11. The system according to claim 8, wherein the antagonist resisting muscle is the flexor muscle.

12. A system for neuromuscular function reeducation and restoring physical function of an at least one neuromuscular system associated with an at least one joint in a patient, the system comprising:

at least one sensor for measuring an electrical signal associated with an agonist muscle in the neuromuscular system of the patient;

at least one sensor for measuring a force signal associated with an antagonist resisting muscle;

at least one electrode for providing a neuromuscular stimulation to the at least one neuromuscular system;

wherein at least one of the electrical signal associated with the agonist muscle and the electrical signal associated with the antagonist resisting muscle is used to provide sensory feedback, the sensory feedback and the neuromuscular stimulation affecting the joint extension and flexion thereby enabling reeducation and restoration of the physical function of the at least one neuromuscular system.

13. The system according to claim 12, wherein the sensory feedback is provided by at least one LED.

14. The system according to claim 12, wherein the at least one sensor for measuring an electrical signal associated with the agonist muscle is an EMG sensor.

15. The system according to claim 12, wherein the antagonist resisting muscle is the flexor muscle.

16. A system for neuromuscular function reeducation and restoring physical function of an at least one neuromuscular system associated with an at least one joint in a patient, the system comprising:

a continuous passive device for allowing the extension and flexion of the joint, said continuous passive device having a mechanical compliance which allows self-actuation of the joint thereby providing neuromuscular function reeducation and restoration of the physical function of the neuromuscular system.

17. The system according to claim 16, wherein the continuous passive device is force activated.

18. The system according to claim 16, wherein the mechanical compliance of the continuous passive device is substantially large.

19. The system according to claim 16, further comprising at least one force sensor for measuring a parameter indicative of resistance of an antagonist resisting muscle, the antagonist resisting muscle being part of the neuromuscular system.

20. The system according to claim 19, wherein the parameter indicative of the resistance of the antagonist resisting muscle is used for affecting the joint extension and flexion thereby enabling reeducation and restoration of the physical function of the at least one neuromuscular system.

21. The system according to claim 16, wherein the at least one force sensor is a force sensitive resistor.

22. The system according to claim 16, wherein the continuous passive device is an air-muscle device.

23. A system for neuromuscular function reeducation and restoring physical function of an at least one neuromuscular system associated with an at least one joint in a patient, the system comprising:

a continuous passive machine including an air-muscle device for allowing the extension and flexion of the joint in the patient;

wherein the continuous passive device enables reeducation and restoration of the physical function of the neuromuscular system in the patient through the at least one of a visual, aural, and tactile feedback of the measured parameters obtained from the patient.

24. The system according to claim 23, wherein the air-muscle device is inflatable.

25. The system according to claim 24, wherein the air-muscle device shortens in length upon inflation thereby causing the joint to pivot about at least one axis.

26. The system according to claim 23, wherein the measured parameters include at least one EMG signal associated with an agonist muscle in the neuromuscular system.

27. The system according to claim 23, wherein the measured parameters include at least one parameter indicative of resistance of at least one antagonist resisting muscle in the neuromuscular system.

28. The system according to claim 23, wherein the visual feedback is provided through at least one LED.

29. A system for neuromuscular function reeducation and restoring physical function of at least one neuromuscular system associated with an at least one joint in a patient, the system comprising:

a motion causing device adjacent to the at least one joint, said motion causing device permitting self-actuation of the at least one neuromuscular system;

at least one force sensor for measuring a parameter indicative of muscle resistance;

at least one joint position sensor for measuring joint movement;

at least one neuromuscular electrical stimulating (NMES) system for providing neuromuscular stimulation to the at least one neuromuscular system;

an electronic memory system that stores information of the patient;

at least one EMG sensor measuring the electrical activity of said at least one neuromuscular system; and

a controller implementing a protocol for affecting the joint motion based on the measurements from the sensors thereby restoring physical function of said neuromuscular system associated with the at least one joint.

30. The system according to claim 29, wherein the stored information in the electronic memory system includes patient compliance and patient performance.

31. The system according to claim 29, wherein the electronic memory system can provide the stored information of the patient on command.

32. The system according to claim 29, wherein the at least one EMG sensor is used for measuring the electrical activity of an agonist neuromuscular system.

33. The system according to claim 29, wherein the motion causing device is an air-muscle.

34. The system according to claim 32, wherein the at least one force sensor is used for measuring a force signal from an antagonist resisting neuromuscular system.

35. The system according to claim 29, wherein the at least one force sensor is a force sensitive resistor.

36. The system according to claim 33, wherein the air-muscle includes at least one port for supplying pressurized air to inflate said air-muscle.

37. The system according to claim 36, wherein the air-muscle shortens in length upon inflation thereby causing the joint to pivot about at least one axis.

38. The system according to claim 29, wherein the joint is a wrist joint.

39. The system according to claim 29, wherein the joint position sensor and the force sensor provide a measure of combined wrist and finger flexor muscle resistance.

40. The system according to claim 30, further including a first display for depicting the electrical activity from the EMG sensor.

41. The system according to claim 40, further including a second display indicating a degree of flexor resistance torque measured by the at least one force sensor.

42. The system according to claim 41, wherein the displays provide a means for the patient to monitor the compliance and performance.

43. The system according to claim 42, wherein the controller updates the displays in a predetermined manner to provide a mechanism for the patient to improve said performance and said compliance.

44. The system according to claim 36, wherein the controller includes a microprocessor for controlling at least one valve for controlling the supply of pressurized air to the air-muscle.

45. A system for providing movement to at least one joint for restoring physical function of at least one neuromuscular system associated with the joint, the device comprising:

at least one inflatable device adjacent to said at least one joint and each device having two ends, wherein one end is connected to a distal element of the joint and the other end to a proximal element of the joint;

a source for supplying pressurized air to the inflatable device;

wherein the inflatable device shortens in length upon inflation thereby causing said at least one joint to pivot about at least one axis.

46. The system according claim 45, wherein the at least one inflatable device is an air-muscle.

47. The system according to claim 45, wherein the supply of pressurized air to the inflatable device is controlled by a controller.

48. The system according to claim 47, further including at least one force sensor for measuring a parameter indicative of muscle resistance.

49. The system according to claim 48, further including at least one joint position sensor for measuring joint movement.

50. The system according to claim 49, further including at least one EMG sensor for measuring the electrical activity of said at least one neuromuscular system.

51. The system according to claim 50, further including at least one neuromuscular electrical stimulating (NMES) system.

52. The system according to claim 51, wherein the controller implements a protocol for affecting the at least one joint motion based on the measurements from the sensors thereby restoring physical function of said neuromuscular system associated with the joint.

53. A method implementing a protocol for restoring physical function of at least one neuromuscular system associated with a joint in a patient, the method comprising:

measuring a first signal indicative of the activity of said muscle through an EMG sensor;

measuring a second signal indicative of the joint motion through a joint position sensor;

measuring a third signal indicative of the muscle resistance through a force sensor;

mapping the measured signals to at least one parameter; and

controlling the air level in an inflatable device in order to optimize said parameter for restoring physical function of said muscle associated with the joint in the patient, the inflatable device being adjacent to the joint and being inflated or deflated through at least one port associated with the device.

54. The method according to claim 53, further including storing information in an electronic memory system, said information including patient compliance and patient performance.

55. The method according to claim 54, further providing the stored information from the electronic memory system to the patient on demand.

56. The method according to claim 53, wherein the EMG sensor is used for measuring the electrical activity of an agonist resisting neuromuscular system.

57. The method according to claim 53, wherein the force sensor is used for measuring the force signal from an antagonist resisting neuromuscular system.

58. The method according to claim 53, wherein the force sensor is a force sensitive resistor.

59. The method according to claim 54, further including the step of displaying the electrical activity from the EMG sensor to the patient through a first display.

60. The method according to claim 59, further including the step of displaying a degree of flexor resistance torque measured by the force sensor through a second display.

61. The method according to claim 60, wherein the displays provide a means for the patient to monitor the compliance and performance.

62. The method according to claim 61, further including the step of updating the displays to provide a mechanism for the patient to improve said performance and said compliance.

63. The method according to claim 53, further providing a stimulation through at least one neuromuscular stimulating electrode to the neuromuscular system.

64. A method implementing a protocol for restoring physical function of at least one neuromuscular system associated with a joint in a patient, the method comprising:

measuring a first signal indicative of antagonist muscle resistance through a force sensor in the neuromuscular system of the patient;

wherein the signal from the antagonist resisting muscle is used to provide sensory feedback for affecting the joint extension and flexion, through the patient's cognitive action, thereby enabling reeducation and restoration of the physical function of the at least one neuromuscular system.

65. The method according to claim 64, further including measuring a second signal indicative of the joint motion through a joint position sensor.

66. The method according to claim 64, further including measuring an electrical signal associated with an agonist muscle in the neuromuscular system of the patient.

67. The method according to claim 64, further including providing a stimulation through at least one neuromuscular stimulating electrode to the neuromuscular system.

68. The method according to claim 66, further including mapping the measured signals to at least one parameter for optimization.

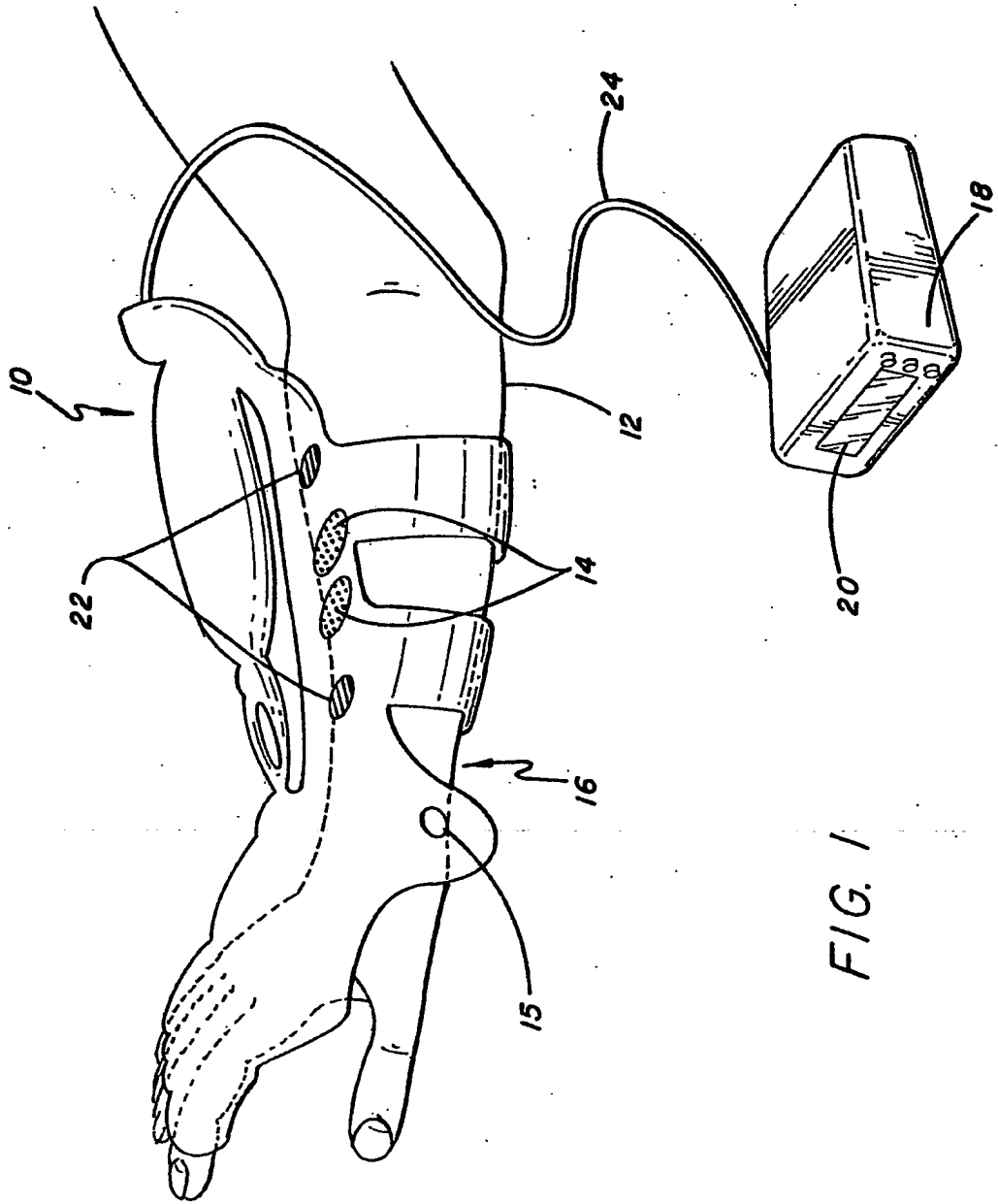

FIG. 1

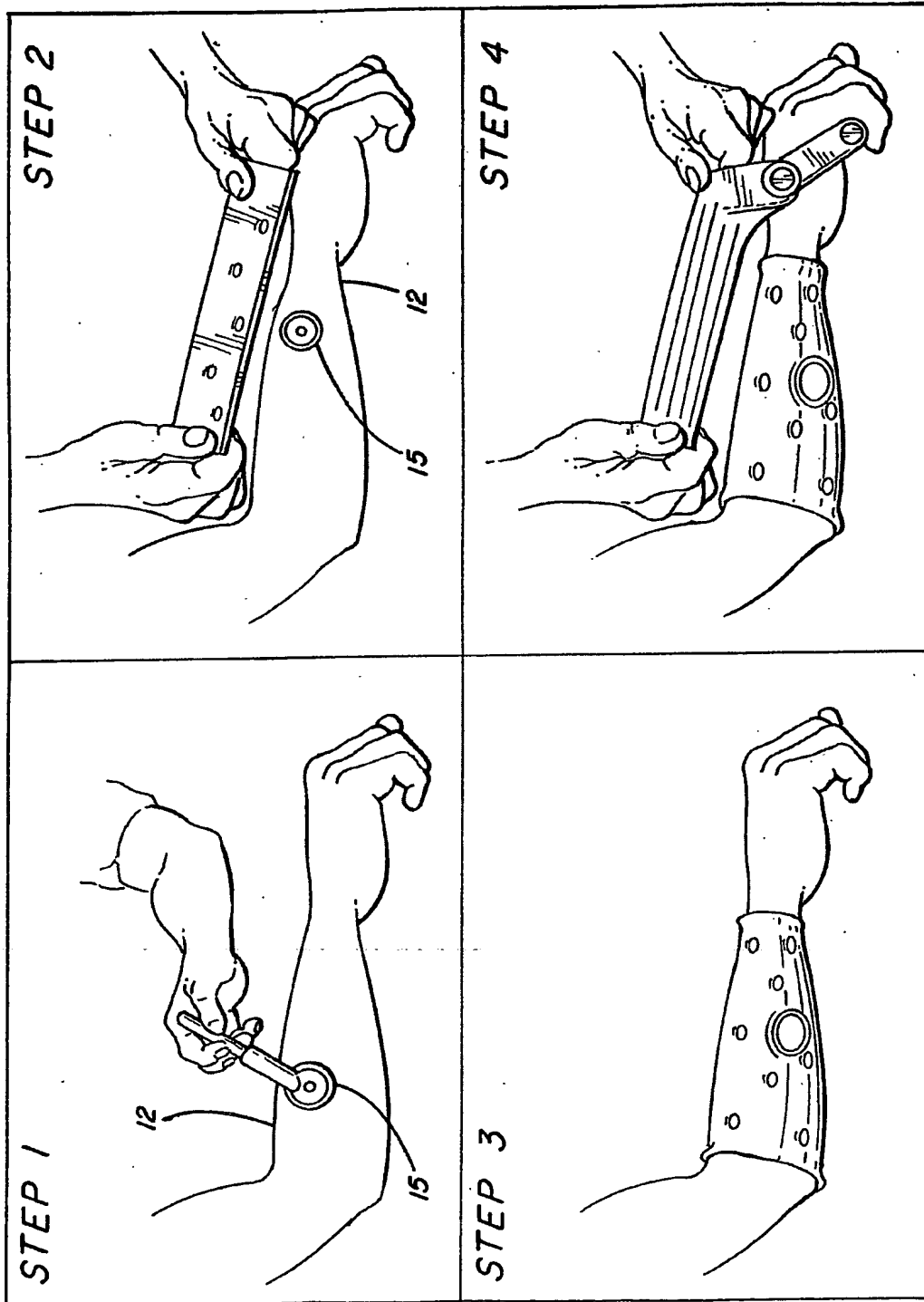

FIG. 2

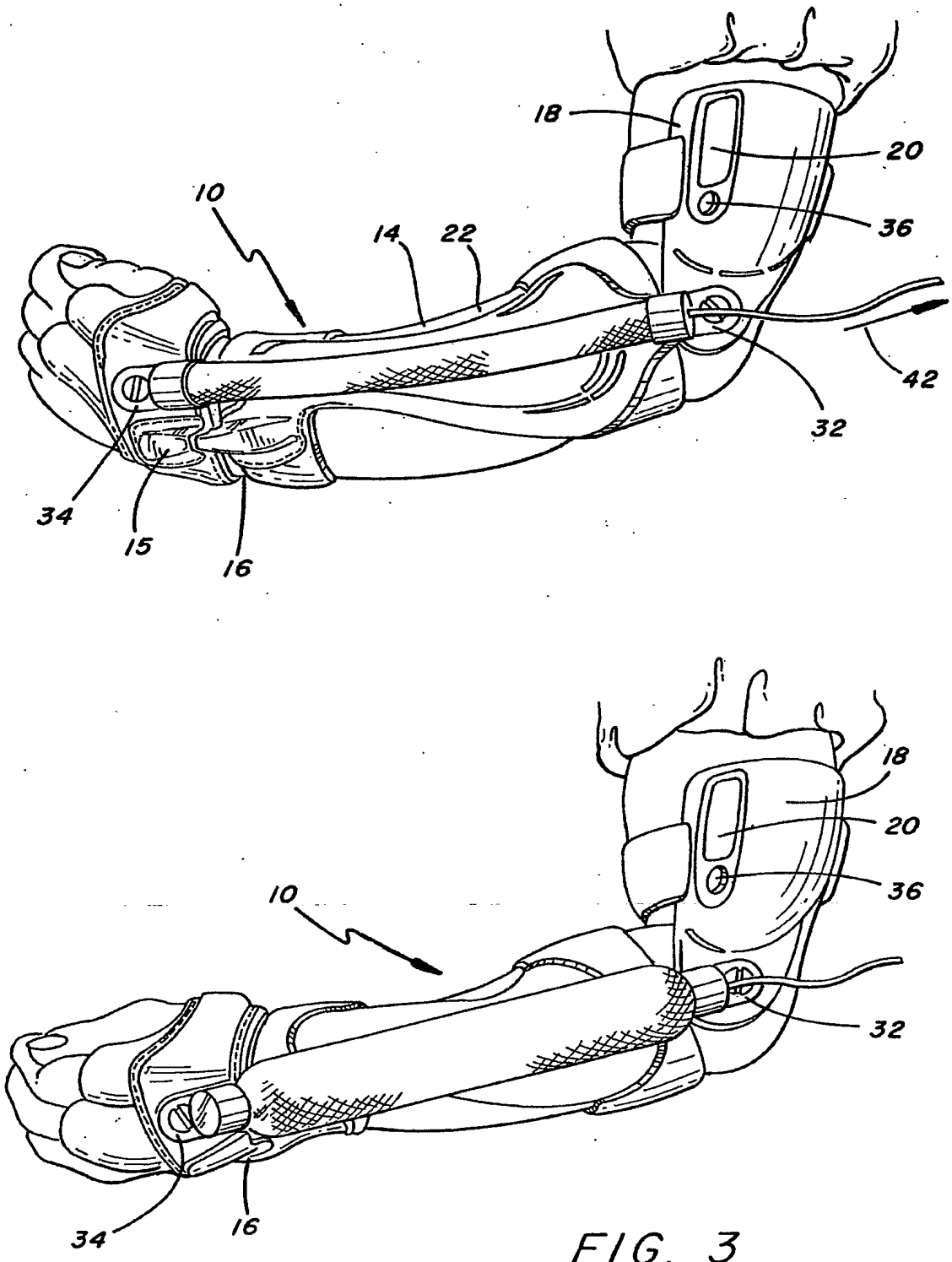

FIG. 3

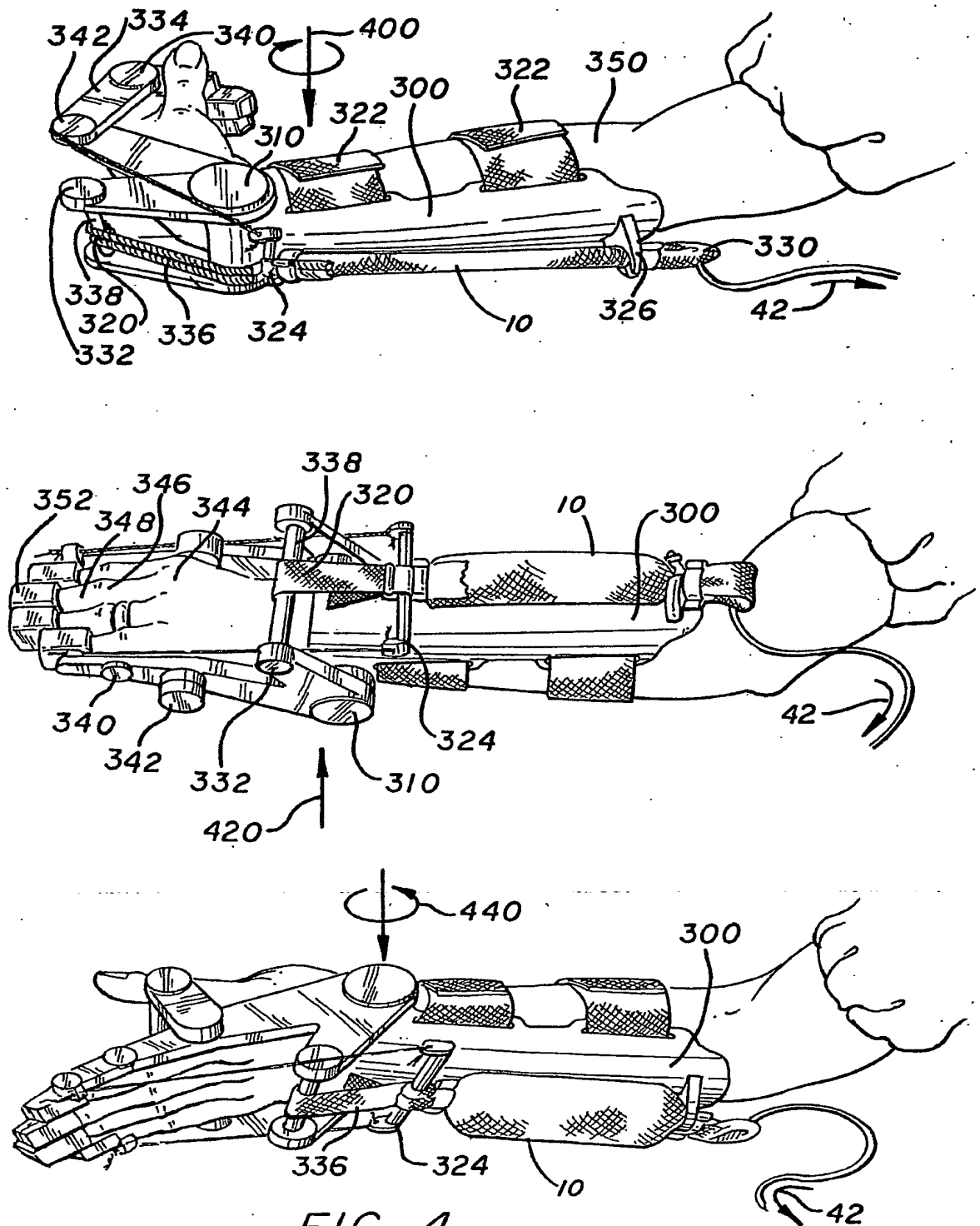

FIG. 4

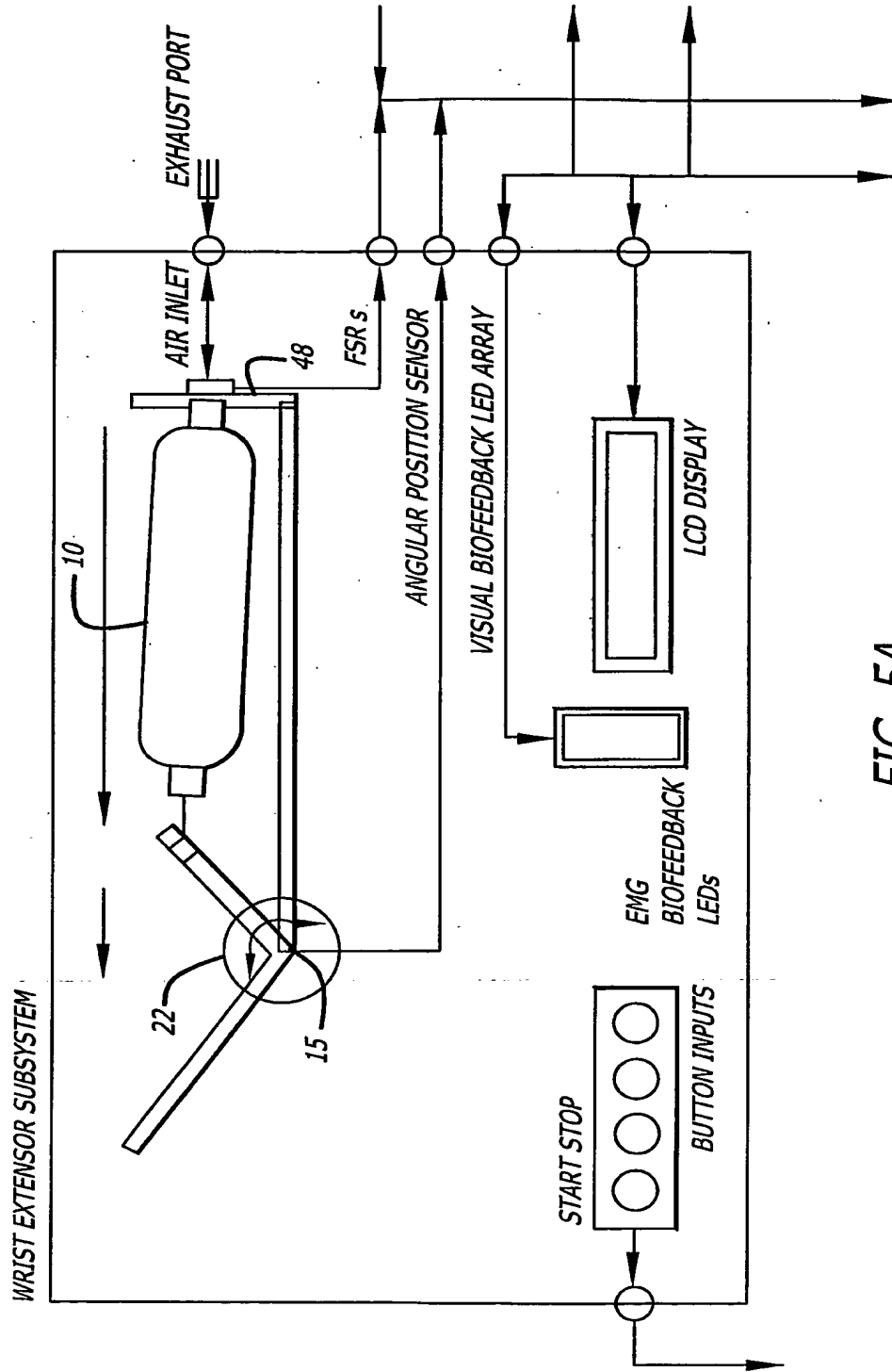

FIG. 5A

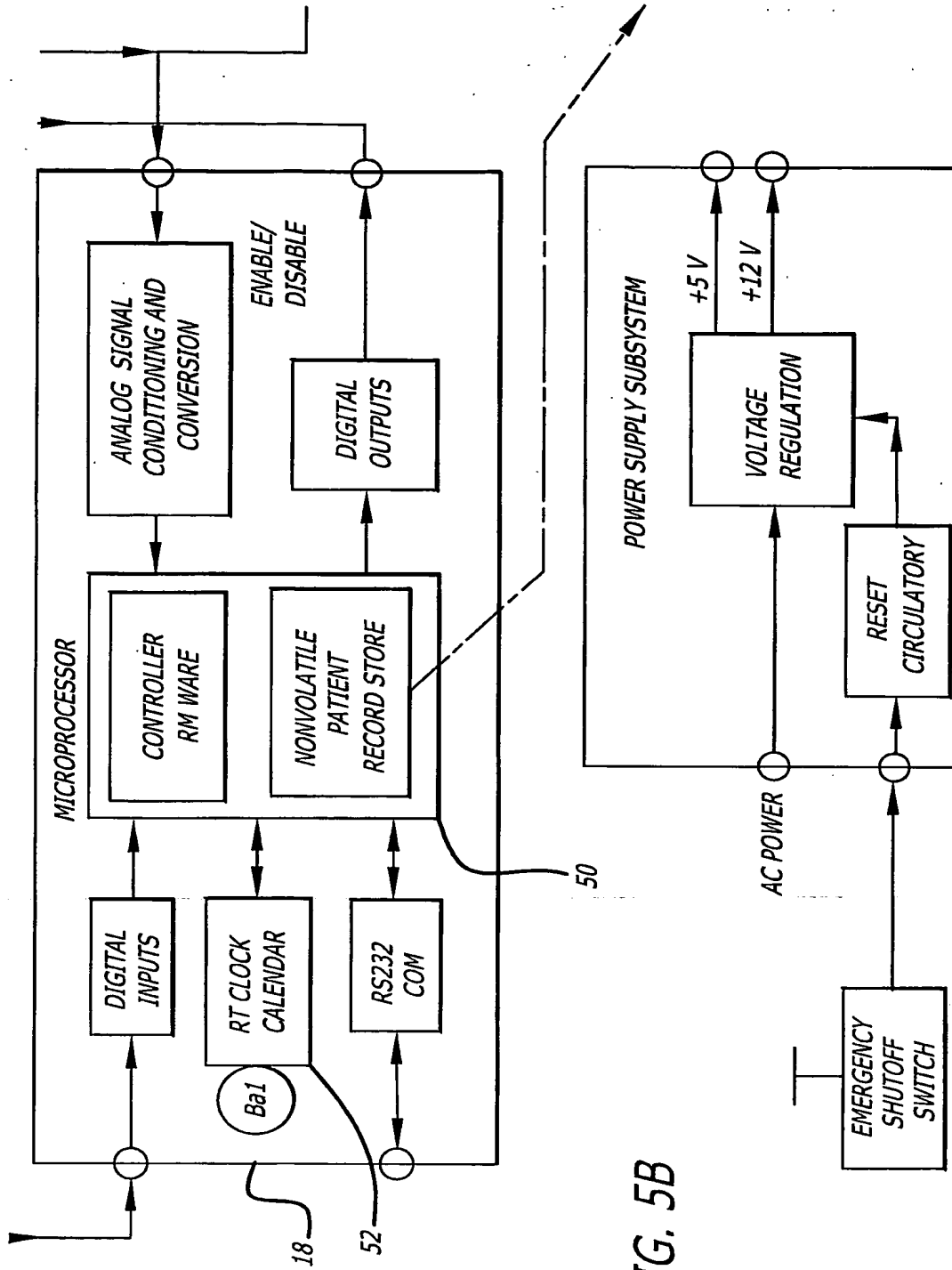

FIG. 5B

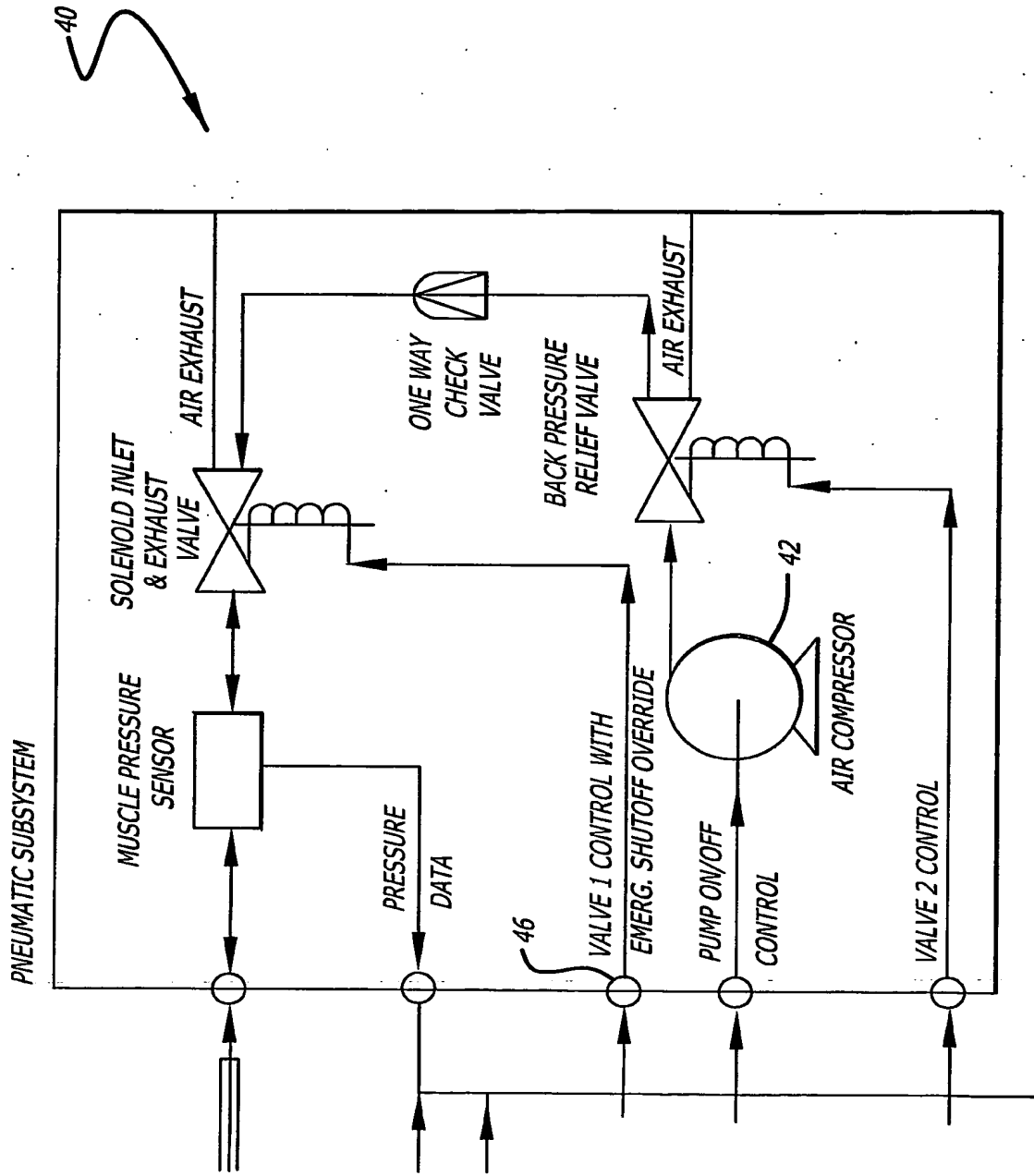

FIG. 5C

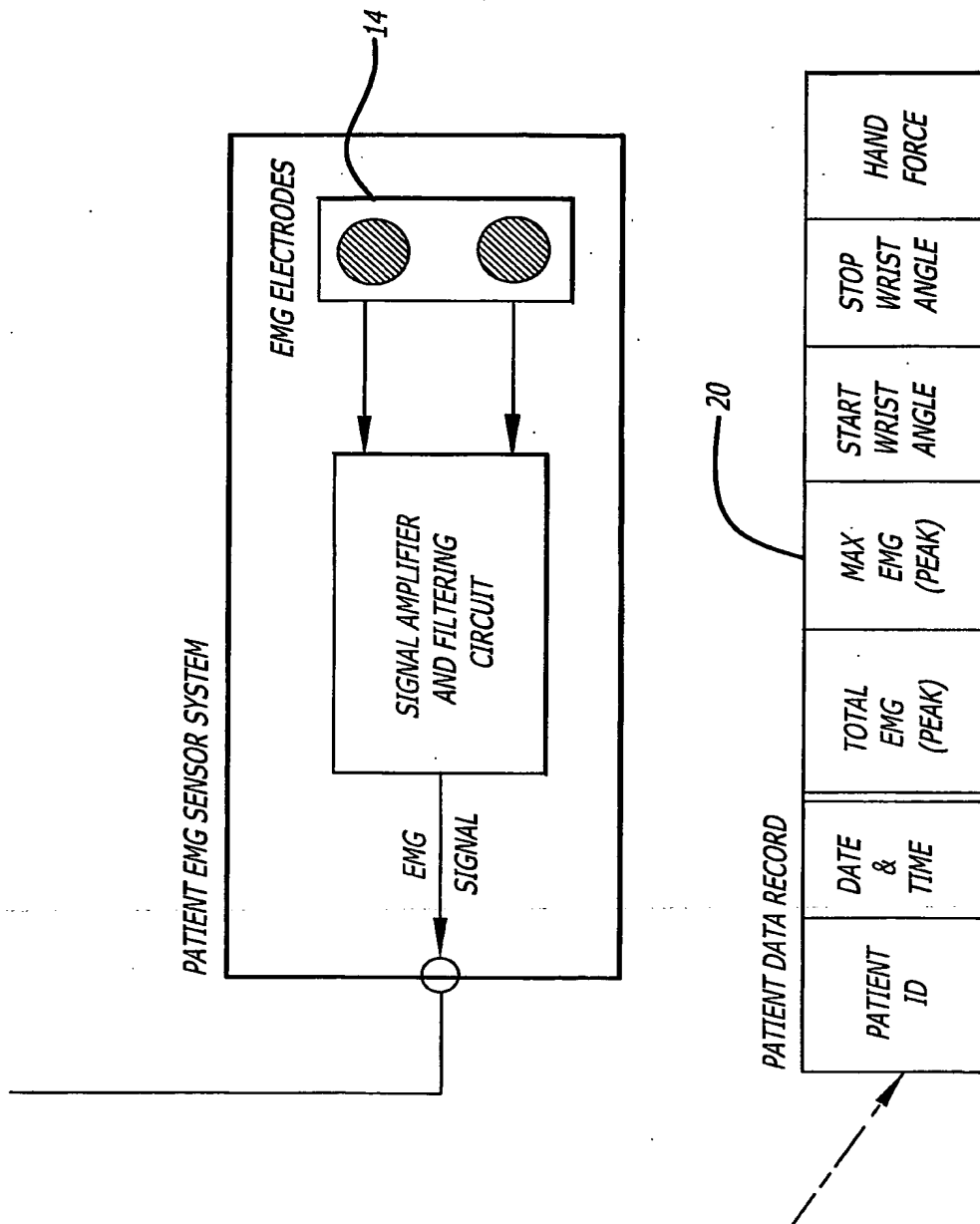

FIG. 5D

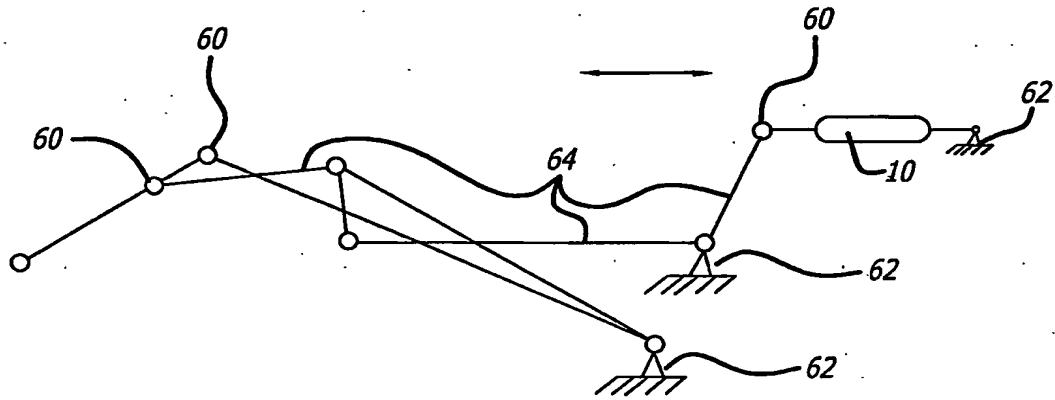

FIG. 6

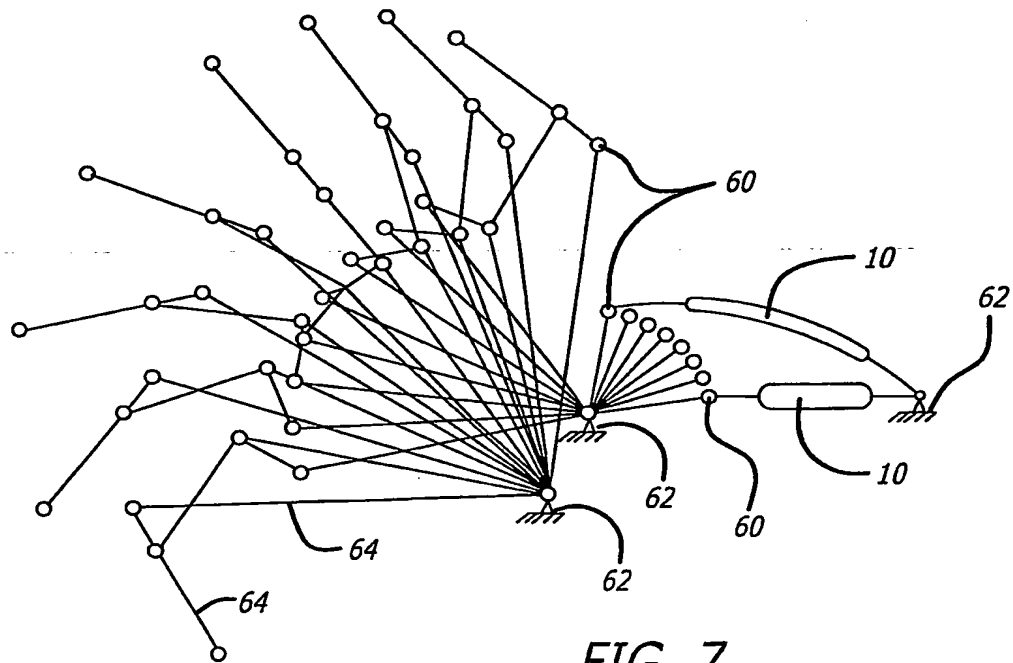

FIG. 7

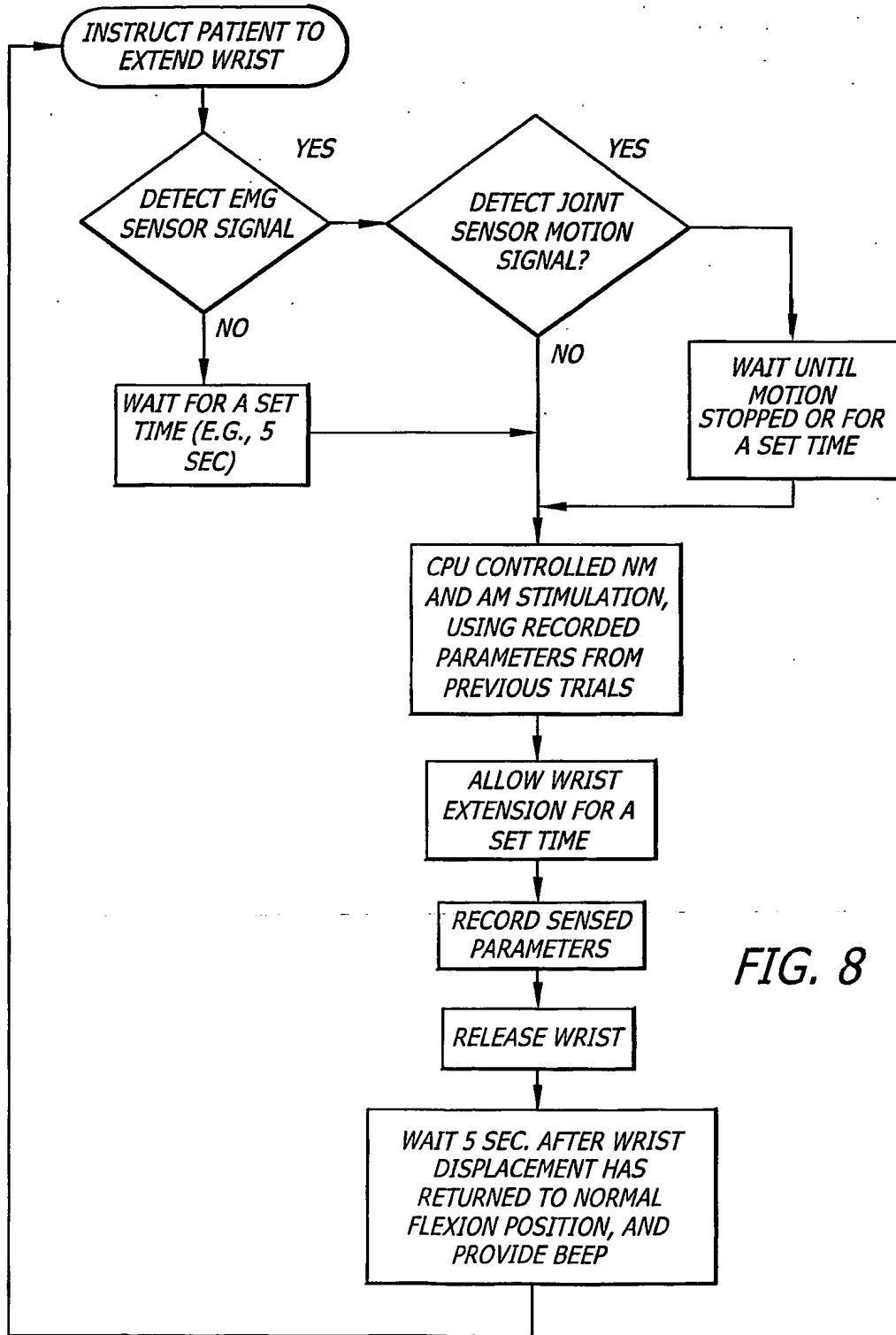

FIG. 8

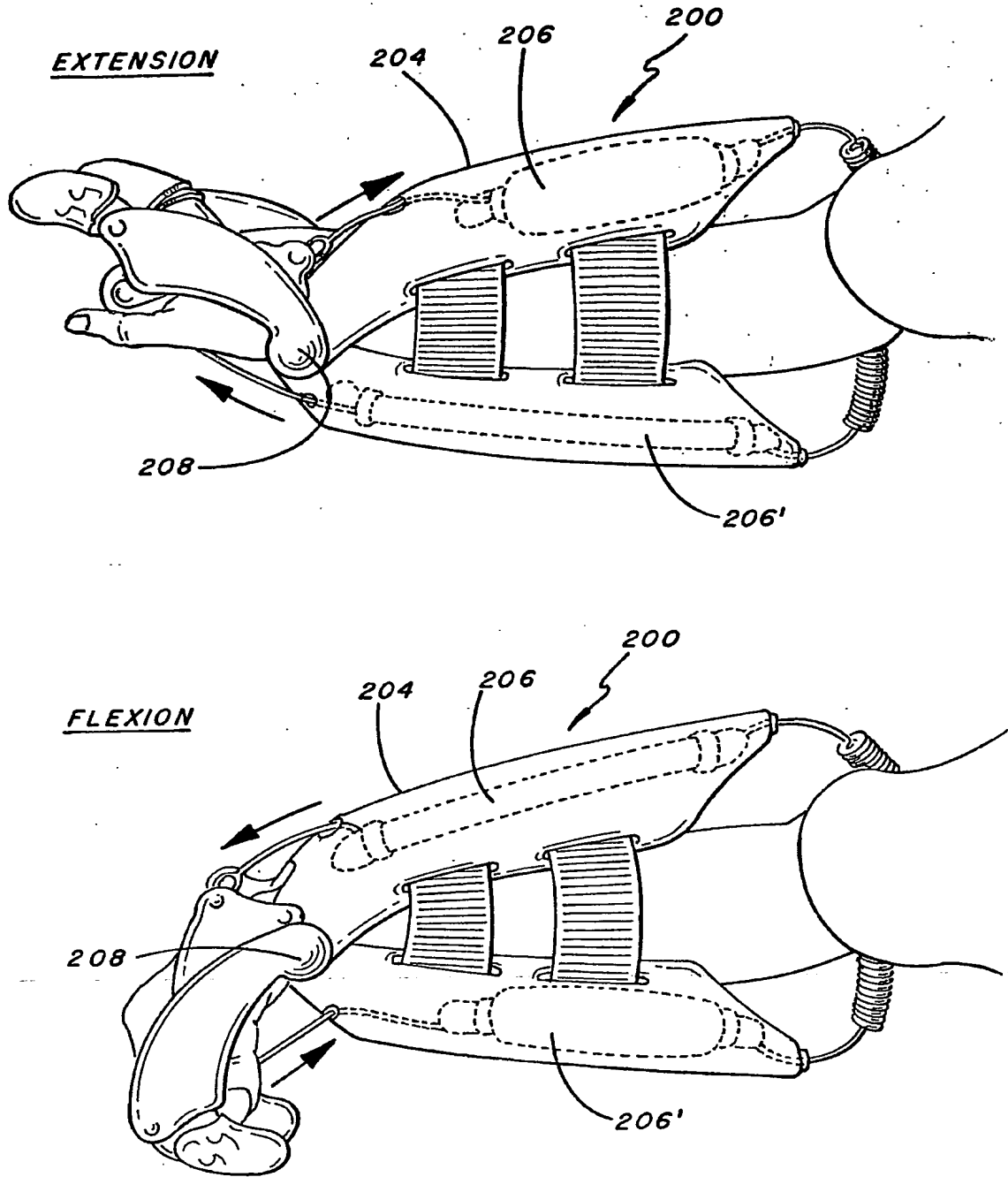

FIG. 9

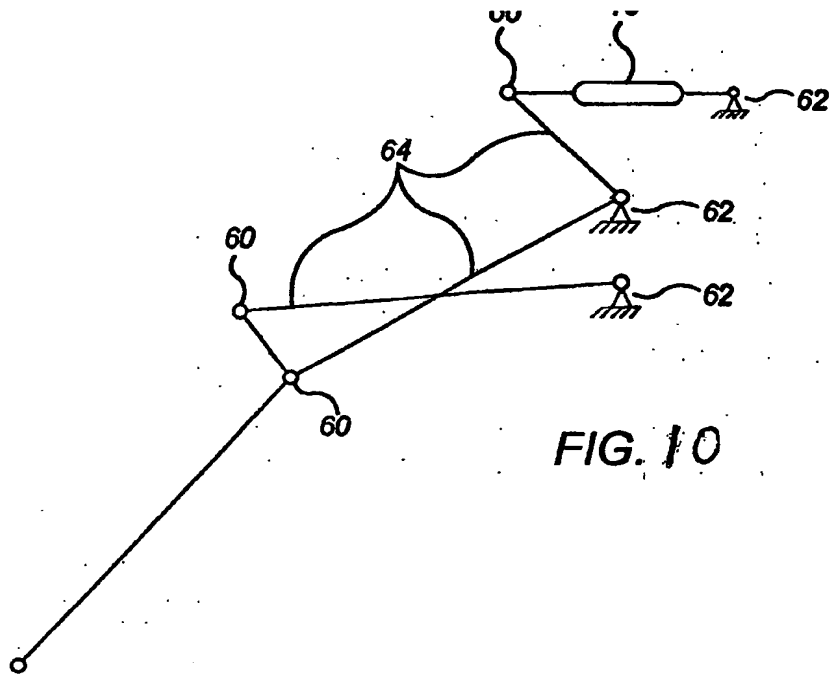

FIG. 10

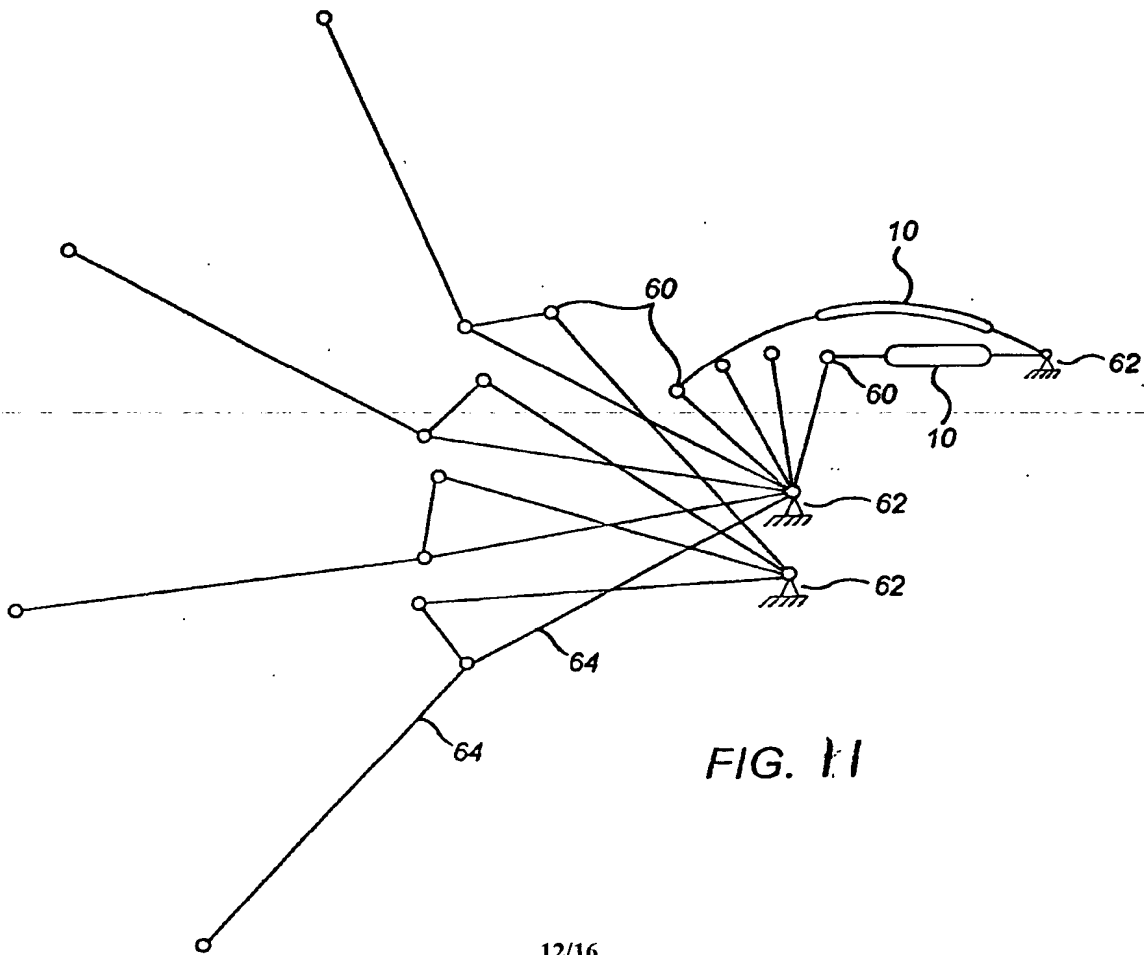
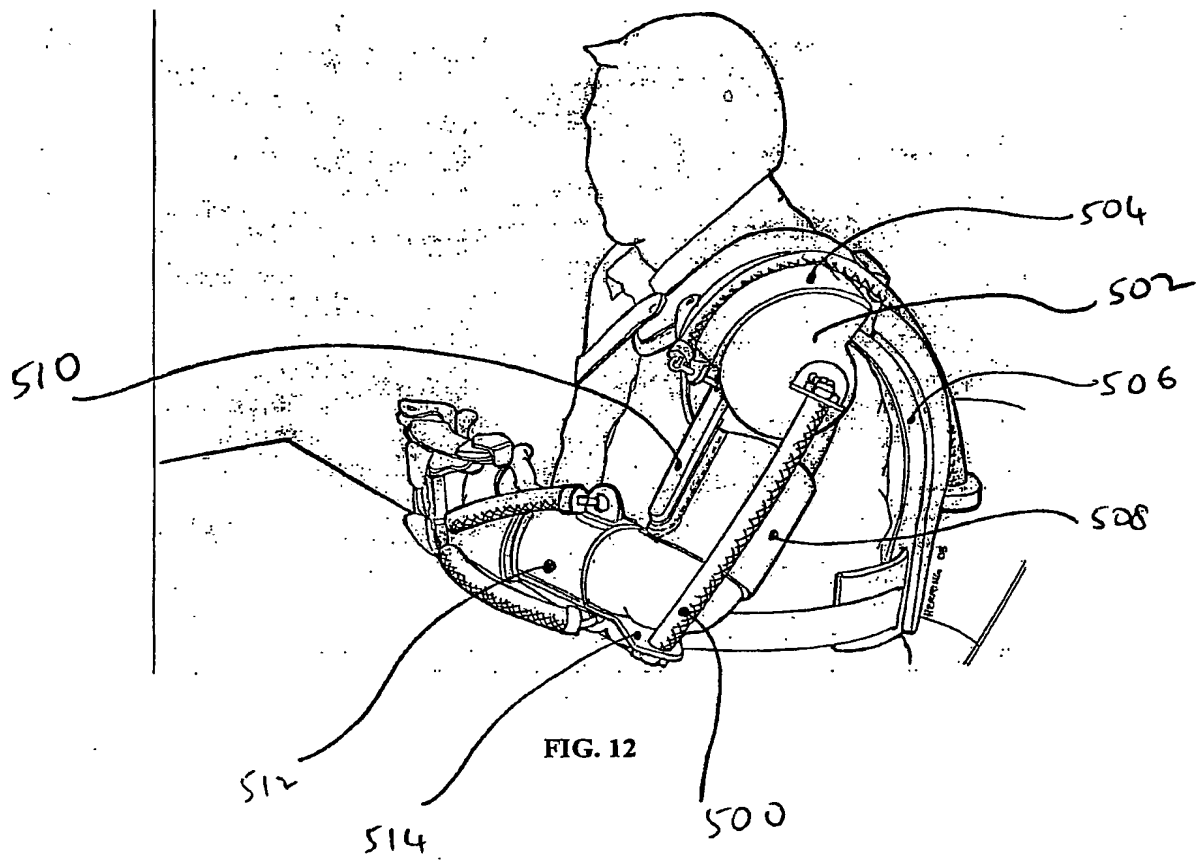

FIG. 11



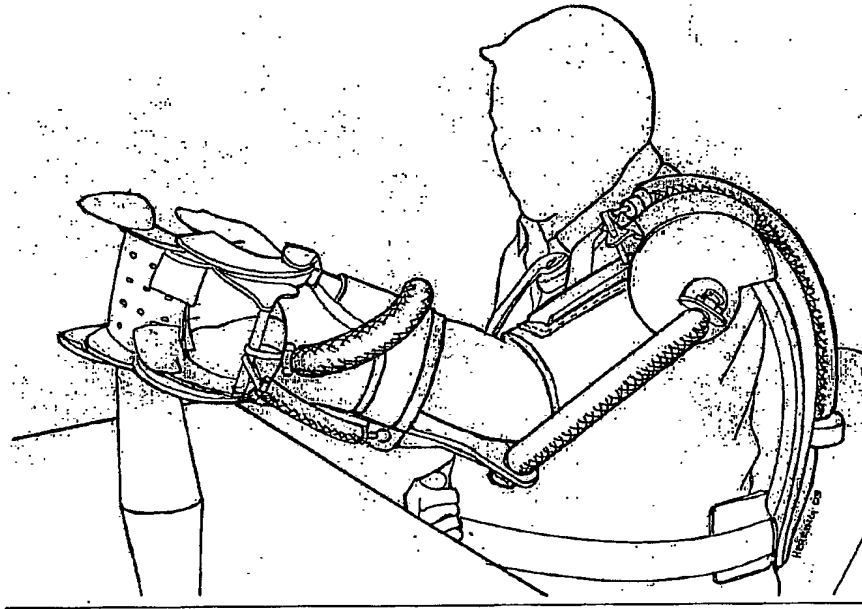

FIG. 13

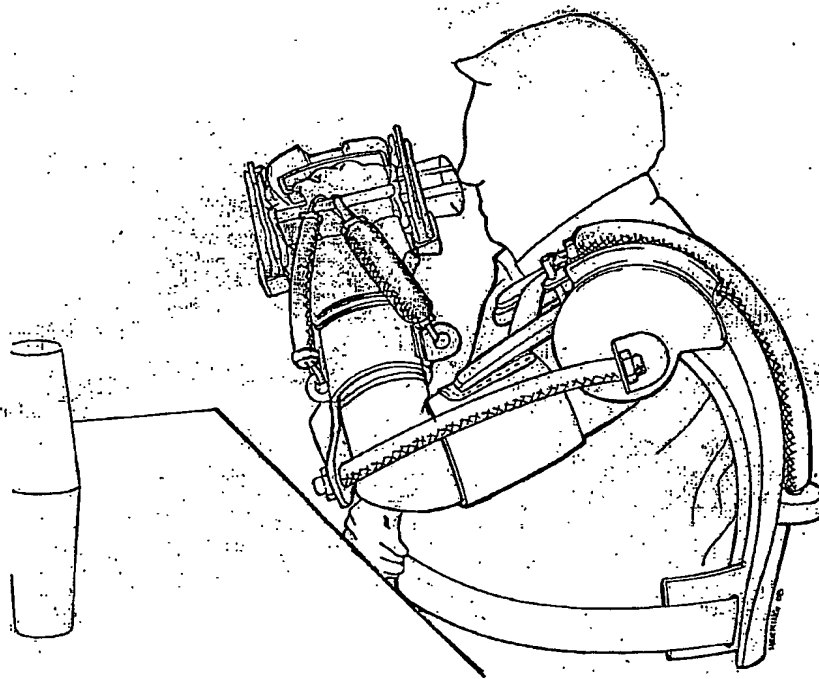

FIG. 14

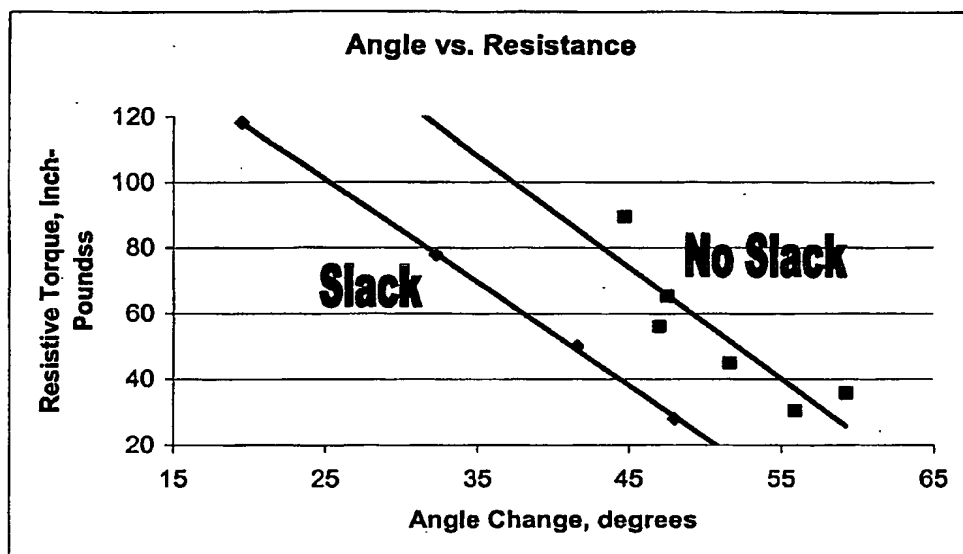

FIG. 15

INTERNATIONAL SEARCH REPORT

International Application No

PCT/US 03/38579

A. CLASSIFICATION OF SUBJECT MATTER IPC 7 A61N1/00 A61B5/00 A61H1/00				
According to International Patent Classification (IPC) or to both national classification and IPC				
B. FIELDS SEARCHED Minimum documentation searched (classification system followed by classification symbols) IPC 7 A61N A61B				
Documentation searched other than minimum documentation to the extent that such documents are included in the fields searched				
Electronic data base consulted during the international search (name of data base and, where practical, search terms used) EPO-Internal				
C. DOCUMENTS CONSIDERED TO BE RELEVANT				
Category *	Citation of document, with indication, where appropriate, of the relevant passages	Relevant to claim No.		
X	WO 02/13673 A (KOTLIK BEN ZION ; STIMEL LTD (IL); ZUKER MORRIS (IL)) 21 February 2002 (2002-02-21) the whole document -----	1-15		
X	US 6 010 468 A (FREER RICHARD JOHN ET AL) 4 January 2000 (2000-01-04) the whole document -----	16-52		
A	US 4 582 049 A (YLVISAKER CARL J) 15 April 1986 (1986-04-15) -----			
A	US 5 562 707 A (PROCHAZKA ARTHUR ET AL) 8 October 1996 (1996-10-08) -----			
A	US 6 456 885 B1 (MAEDA TAKASHI ET AL) 24 September 2002 (2002-09-24) ----- -/--			
<table style="width: 100%; border: none;"> <tr> <td style="width: 50%; border: none;"> <input checked="" type="checkbox"/> Further documents are listed in the continuation of box C. </td> <td style="width: 50%; border: none;"> <input checked="" type="checkbox"/> Patent family members are listed in annex. </td> </tr> </table>			<input checked="" type="checkbox"/> Further documents are listed in the continuation of box C.	<input checked="" type="checkbox"/> Patent family members are listed in annex.
<input checked="" type="checkbox"/> Further documents are listed in the continuation of box C.	<input checked="" type="checkbox"/> Patent family members are listed in annex.			
<table style="width: 100%; border: none;"> <tr> <td style="width: 50%; border: none;"> * Special categories of cited documents : *A* document defining the general state of the art which is not considered to be of particular relevance *E* earlier document but published on or after the international filing date *L* document which may throw doubts on priority claim(s) or which is cited to establish the publication date of another citation or other special reason (as specified) *O* document referring to an oral disclosure, use, exhibition or other means *P* document published prior to the international filing date but later than the priority date claimed </td> <td style="width: 50%; border: none;"> *T* later document published after the international filing date or priority date and not in conflict with the application but cited to understand the principle or theory underlying the invention *X* document of particular relevance; the claimed invention cannot be considered novel or cannot be considered to involve an inventive step when the document is taken alone *Y* document of particular relevance; the claimed invention cannot be considered to involve an inventive step when the document is combined with one or more other such documents, such combination being obvious to a person skilled in the art. *Z* document member of the same patent family </td> </tr> </table>			* Special categories of cited documents : *A* document defining the general state of the art which is not considered to be of particular relevance *E* earlier document but published on or after the international filing date *L* document which may throw doubts on priority claim(s) or which is cited to establish the publication date of another citation or other special reason (as specified) *O* document referring to an oral disclosure, use, exhibition or other means *P* document published prior to the international filing date but later than the priority date claimed	*T* later document published after the international filing date or priority date and not in conflict with the application but cited to understand the principle or theory underlying the invention *X* document of particular relevance; the claimed invention cannot be considered novel or cannot be considered to involve an inventive step when the document is taken alone *Y* document of particular relevance; the claimed invention cannot be considered to involve an inventive step when the document is combined with one or more other such documents, such combination being obvious to a person skilled in the art. *Z* document member of the same patent family
* Special categories of cited documents : *A* document defining the general state of the art which is not considered to be of particular relevance *E* earlier document but published on or after the international filing date *L* document which may throw doubts on priority claim(s) or which is cited to establish the publication date of another citation or other special reason (as specified) *O* document referring to an oral disclosure, use, exhibition or other means *P* document published prior to the international filing date but later than the priority date claimed	*T* later document published after the international filing date or priority date and not in conflict with the application but cited to understand the principle or theory underlying the invention *X* document of particular relevance; the claimed invention cannot be considered novel or cannot be considered to involve an inventive step when the document is taken alone *Y* document of particular relevance; the claimed invention cannot be considered to involve an inventive step when the document is combined with one or more other such documents, such combination being obvious to a person skilled in the art. *Z* document member of the same patent family			
Date of the actual completion of the international search <p style="text-align: center; font-weight: bold;">13 May 2004</p>	Date of mailing of the international search report <p style="text-align: center; font-weight: bold;">24/05/2004</p>			
Name and mailing address of the ISA European Patent Office, P.B. 5818 Patentlaan 2 NL - 2280 HV Rijswijk Tel. (+31-70) 340-2040, Tx. 31 651 epo nl, Fax: (+31-70) 340-3016	Authorized officer <p style="text-align: center; font-weight: bold;">Sánchez y Sánchez, J</p>			

INTERNATIONAL SEARCH REPORT

International Application No

PCT/US 03/38579

C.(Continuation) DOCUMENTS CONSIDERED TO BE RELEVANT

Category *	Citation of document, with indication, where appropriate, of the relevant passages	Relevant to claim No.
A	US 6 064 912 A (KENNEY JOHN P) 16 May 2000 (2000-05-16) -----	

FURTHER INFORMATION CONTINUED FROM PCT/ISA/ 210

Continuation of Box I.1

Claims Nos.: 53-68

Rule 39.1(iv) PCT - Method for treatment of the human or animal body by therapy

INTERNATIONAL SEARCH REPORT

International application No.
PCT/US 03/38579

Box I Observations where certain claims were found unsearchable (Continuation of Item 1 of first sheet)

This International Search Report has not been established in respect of certain claims under Article 17(2)(a) for the following reasons:

1. Claims Nos.: 53-68
because they relate to subject matter not required to be searched by this Authority, namely:
Rule 39.1(iv) PCT - Method for treatment of the human or animal body by therapy
2. Claims Nos.:
because they relate to parts of the International Application that do not comply with the prescribed requirements to such an extent that no meaningful International Search can be carried out, specifically:
3. Claims Nos.:
because they are dependent claims and are not drafted in accordance with the second and third sentences of Rule 6.4(a).

Box II Observations where unity of invention is lacking (Continuation of item 2 of first sheet)

This International Searching Authority found multiple inventions in this International application, as follows:

see additional sheet

1. As all required additional search fees were timely paid by the applicant, this International Search Report covers all searchable claims.
2. As all searchable claims could be searched without effort justifying an additional fee, this Authority did not invite payment of any additional fee.
3. As only some of the required additional search fees were timely paid by the applicant, this International Search Report covers only those claims for which fees were paid, specifically claims Nos.:
4. No required additional search fees were timely paid by the applicant. Consequently, this International Search Report is restricted to the invention first mentioned in the claims; it is covered by claims Nos.:

Remark on Protest

- The additional search fees were accompanied by the applicant's protest.
- No protest accompanied the payment of additional search fees.

INTERNATIONAL SEARCH REPORT

Information on patent family members

International Application No

PCT/US 03/38579

Patent document cited in search report	Publication date	Patent family member(s)	Publication date
WO 0213673	A	21-02-2002	AU 8007001 A 25-02-2002
			EP 1311320 A2 21-05-2003
			WO 0213673 A2 21-02-2002
			US 2003208246 A1 06-11-2003

US 6010468	A	04-01-2000	WO 0145558 A1 28-06-2001
			AU 2712000 A 03-07-2001
			EP 1239772 A1 18-09-2002

US 4582049	A	15-04-1986	DE 3516279 A1 13-11-1986
			FR 2580934 A1 31-10-1986
			GB 2175504 A 03-12-1986

US 5562707	A	08-10-1996	AU 678065 B2 15-05-1997
			AU 7850694 A 04-05-1995
			BR 9407821 A 06-05-1997
			DE 69407987 D1 19-02-1998
			DE 69407987 T2 10-06-1998
			EP 0725665 A1 14-08-1996
			JP 9503937 T 22-04-1997
			PL 313937 A1 05-08-1996
			AT 162089 T 15-01-1998
			CA 2173430 A1 20-04-1995
			WO 9510323 A1 20-04-1995
			CN 1135722 A 13-11-1996
			DK 725665 T3 14-04-1998
			ES 2111336 T3 01-03-1998

US 6456885	B1	24-09-2002	JP 3026007 B2 27-03-2000
			JP 2000279536 A 10-10-2000

US 6064912	A	16-05-2000	US 5891068 A 06-04-1999
			AU 740869 B2 15-11-2001
			AU 6587498 A 22-10-1998
			CA 2285662 A1 08-10-1998
			EP 0971653 A1 19-01-2000
			JP 2002514108 T 14-05-2002
			WO 9843560 A1 08-10-1998
			US 6456884 B1 24-09-2002
			US 6001074 A 14-12-1999
			US 6206846 B1 27-03-2001